

Taurus

User's Manual











Foreword

General

This manual introduces the functions and operations of Taurus monocular camera (hereinafter referred to as "the Camera"). Read carefully before using the device, and keep the manual safe for future reference.

Safety Instructions

The following signal words might appear in the manual.

Signal Words	Meaning
 DANGER	Indicates a high potential hazard which, if not avoided, will result in death or serious injury.
 WARNING	Indicates a medium or low potential hazard which, if not avoided, could result in slight or moderate injury.
 CAUTION	Indicates a potential risk which, if not avoided, could result in property damage, data loss, reductions in performance, or unpredictable results.
 ESD	Electrostatic Sensitive Devices. Indicates a device that is sensitive to electrostatic discharge.
 ELECTRIC SHOCK	Indicates dangerous high voltage. Take care to avoid coming into contact with electricity.
 LASER RADIATION	Indicates a laser radiation hazard. Take care to avoid exposure to a laser beam.
 TIPS	Provides methods to help you solve a problem or save time.
 NOTE	Provides additional information as a supplement to the text.

Revision History

Version	Revision Content	Release Time
V1.0.0	First release.	September 2024

Privacy Protection Notice

As the device user or data controller, you might collect the personal data of others such as their face, fingerprints, and license plate number. You need to be in compliance with your local privacy protection laws and regulations to protect the legitimate rights and interests of other people by implementing measures which include but are not limited: Providing clear and visible identification to inform people of the existence of the surveillance area and provide required contact information.

About the Manual

- The manual is for reference only. Slight differences might be found between the manual and the product.
- We are not liable for losses incurred due to operating the product in ways that are not in

compliance with the manual.

- The manual will be updated according to the latest laws and regulations of related jurisdictions. For detailed information, see the paper user's manual, use our CD-ROM, scan the QR code or visit our official website. The manual is for reference only. Slight differences might be found between the electronic version and the paper version.
- All designs and software are subject to change without prior written notice. Product updates might result in some differences appearing between the actual product and the manual. Please contact customer service for the latest program and supplementary documentation.
- There might be errors in the print or deviations in the description of the functions, operations and technical data. If there is any doubt or dispute, we reserve the right of final explanation.
- Upgrade the reader software or try other mainstream reader software if the manual (in PDF format) cannot be opened.
- All trademarks, registered trademarks and company names in the manual are properties of their respective owners.
- Please visit our website, contact the supplier or customer service if any problems occur while using the device.
- If there is any uncertainty or controversy, we reserve the right of final explanation.

Important Safeguards and Warnings

This section introduces content covering the proper handling of the device, hazard prevention, and prevention of property damage. Read carefully before using the device, and comply with the guidelines when using it.

Transportation Requirements



- Transport the Camera within the allowed humidity and temperature conditions.
- Do not fall, squeeze, violently vibrate or immerse the device in liquid when transporting. Gently pick and place the Camera when moving, prevent the internal equipment becoming damaged or cable connection becoming loose.
- Do not transport the Camera without package. Use the factory default package or material of equal quality to pack the Camera when transporting it, otherwise the Camera can become easily damaged.

Storage Requirements



- Store the Camera within the allowed humidity and temperature conditions.
- Do not place the device in a humid, dusty or extremely hot or cold site that has strong electromagnetic radiation or unstable illumination.
- Do not squeeze, violently vibrate or immerse the device in liquid.
- Do not mechanically vibrate or crash when storing.
- Store the Camera in a ventilated place that has no strong electromagnetic radiation.
- For long-term storage of the battery, make sure that it is fully charged every half year to ensure the battery quality. Otherwise, damage may occur.

Operation Requirements



- Prevent liquid from flowing into the Camera to avoid damage to the internal components.
- Do not stuff foreign materials into the Camera to prevent a short circuit which could result in the Camera being damaged or people becoming injured.
- Do not expose the device to high electromagnetic radiation or dusty environments.
- Do not aim the lens at the sun or any other bright light.
- Improper use or replacement of the battery may result in explosion hazard.
- Do not charge other battery types with the supplied charger. Confirm there is no flammable material within 2 m of the charger during charging.
- Make sure that the plug is properly connected to the power socket.
- Do not connect multiple devices to one power adapter, to avoid over-heating or fire hazards caused by overload.
- If smoke, odor, or noise arises from the device, immediately turn off the power, unplug the power cable, and contact the service center.



- Do not dismantle the Camera. The internal components can only be repaired by a qualified professional. Dismantling it without professional assistance might cause water seeping in or might result in the Camera producing poor quality images.
- Operating temperature: $-30\text{ }^{\circ}\text{C}$ to $+55\text{ }^{\circ}\text{C}$ ($-22\text{ }^{\circ}\text{F}$ to $+121\text{ }^{\circ}\text{F}$), and the operating humidity shall be 95% or less.

Maintenance and Repair Requirements



DANGER

- Prevent liquid from flowing into the Camera to avoid damage to the internal components. In case the liquid enters the Camera, immediately stop using the Camera, cut off the power, and disconnect all the cables, and then contact your local customer service center.
- Use the accessories regulated by the manufacturer. The Camera should be maintained by qualified professionals.
- Make sure to cut off the power before cleaning the Camera, to prevent electric shock.



WARNING

If the Camera malfunctions, contact your local customer service center. Do not dismantle the Camera.



- Clean the Camera body with a piece of soft dry cloth. For any dirt that is hard to remove, pick up a piece of clean and soft cloth, dip it into a little neutral detergent and gently wipe the dust away. After that, wipe away all the remaining liquid on the Camera with another dry cloth. Never use volatile solvents such as alcohol, benzene and thinner, or cleaners that are strong and abrasive. Otherwise, the Camera's surface coating will be damaged and its working performance will be encumbered.
- Save the factory package of the Camera. When the Camera malfunctions, pack the Camera with the factory package and send to the dealer.

Laser Requirements



LASER RADIATION

Laser can cause damages to eyes. Do not look directly at the laser beam or observe the beam with optical devices when the laser is on.

Table of Contents

Foreword	I
Important Safeguards and Warnings.....	III
1 Product Introduction	1
2 Structure	2
2.1 Packing List.....	2
2.2 Device Description.....	3
3 Basic Operation	6
3.1 Starting and Shutdown	6
3.2 Image Adjustment.....	6
3.2.1 Adjusting Focus	6
3.2.2 Setting Color Palettes.....	6
3.2.3 Setting Brightness.....	9
3.2.4 Setting Contrast	9
3.2.5 Setting Sharpness.....	9
3.3 Configuring the Camera.....	10
3.3.1 Menu Description	10
3.3.2 Brief Menu	10
3.3.3 Standard Menu	11
3.3.3.1 Setting Forest Mode	11
3.3.3.2 Setting Wi-Fi Connection	11
3.3.3.3 Setting Hot Point.....	12
3.3.3.4 Setting Auto FFC.....	12
3.3.3.5 Setting Auto Record	12
3.3.3.6 Setting DPC.....	12
3.3.3.7 Setting Menu Size.....	13
3.3.3.8 Setting Zeroing	13
3.3.3.9 Setting Zeroing Profile.....	14
3.3.3.10 Setting Ranging Mode.....	14
3.3.3.11 Setting Laser Ranging.....	15
3.3.3.11.1 Measurement Considerations.....	15
3.3.3.11.2 Setting Laser Ranging Mode	16
3.3.3.12 System Settings.....	16
3.3.3.13 Viewing the Version.....	17
3.3.3.14 Restoring Default.....	17
3.4 Video and Snapshot	17

3.4.1 Recording Videos	17
3.4.1.1 Auto Recording	17
3.4.1.2 Recording Videos	17
3.4.2 Capturing Images	18
3.4.3 Exporting File	18
3.5 Power Supply	18
3.5.1 Installing the Battery	18
3.5.2 Charging	19
4 System Update	20
4.1 Upgrading Manually	20
4.2 Upgrading through App	20
Appendix 1 Compliance Notice	21

1 Product Introduction

The thermal monocular camera captures sharp thermal imaging at a fast frame rate for smooth, impeccable vision on running targets and from moving vehicles. Designed to increase situational awareness at any time of day, the Camera can detect humans, animals, and objects in complete darkness, haze, or through glaring light, equipping law enforcement professionals, hunters, and outdoor enthusiasts with reliable thermal imaging in tough conditions. Featuring the laser range finder, the Camera can accurately measure the target distance. It is widely used in outdoor scenarios for hunting, animal observation, and more.

2 Structure

2.1 Packing List

Figure 2-1 Packing list

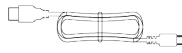

Type-C Cable × 1



Battery × 1

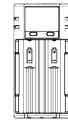

Battery Charger × 1

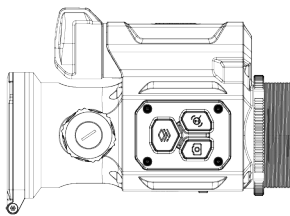

Thermal Monocular Camera × 1



Wrench × 1



Heating sticker × 5



Lens Cloth × 1



Camera Pouch × 1



Quick Start Guide × 1



Legal and Regulatory Information × 1



Warranty Card × 1

2.2 Device Description

Figure 2-2 Button description (with LRF)

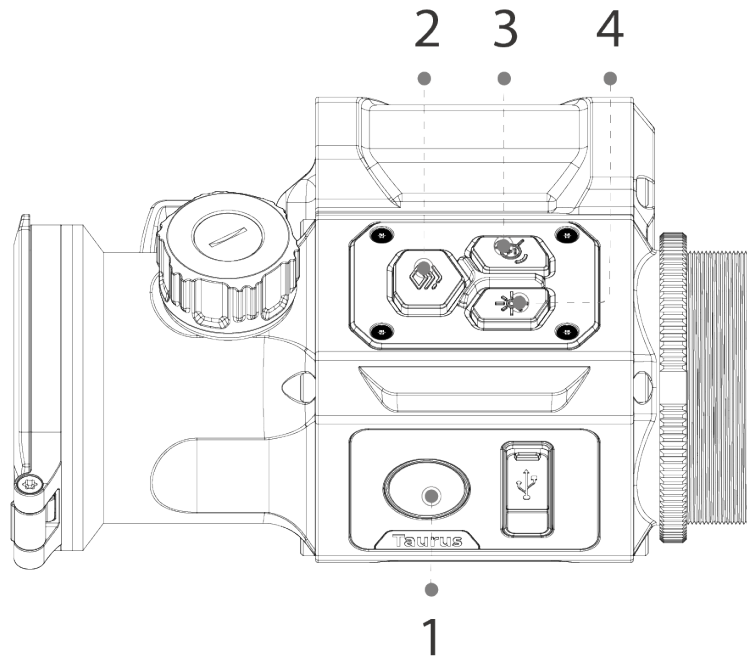

Figure 2-3 Button description (without LRF)

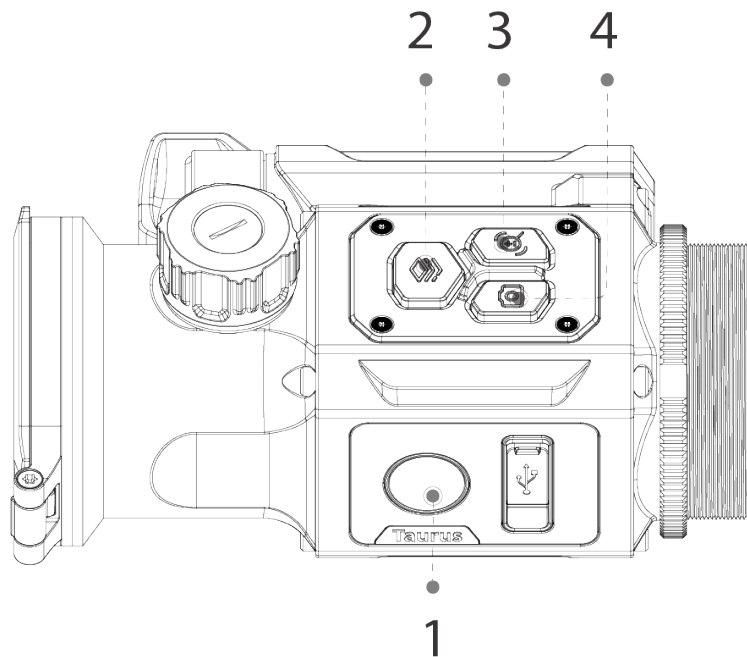

Table 2-1 Button description (with LRF)

No.	Name	Description
1	Power button	<ul style="list-style-type: none"> ● Press and hold to start or shut down the Camera. ● Press to enable or disable the sleep mode..
2	Menu button	<ul style="list-style-type: none"> ● Press and hold to go to the standard menu. ● Press to go to the brief menu. ● Double-press to select the pseudo color.

No.	Name	Description
3	Zoom button	<ul style="list-style-type: none"> • Press to toggle the menu sizes. • Press and hold to manually adjust the shutter.
4	Laser button	<ul style="list-style-type: none"> • Press the button to enable the laser ranging mode. • Press and hold to record videos. <p>⚠ DANGER Laser can cause damages to eyes. Do not look directly at the laser beam or observe the beam with optical devices when the laser is on.</p> <p></p> <ul style="list-style-type: none"> • Make sure that you have set the laser ranging mode before enabling the function. For detail, see "3.3.3.11 Setting Laser Ranging". • The ranging function is only available when the distance is longer than 10 m.
5	Laser button +Menu button	Press the two buttons at the same time to capture images.

Table 2-2 Button description (without LRF)

No.	Name	Description
1	Power button	<ul style="list-style-type: none"> • Press and hold to start or shut down the Camera. • Press to enable or disable the sleep mode.
2	Menu button	<ul style="list-style-type: none"> • Press and hold to go to the standard menu. • Press to go to the brief menu. • Double-press to select the pseudo color.
3	Zoom button	<ul style="list-style-type: none"> • Press to toggle the menu sizes. • Press and hold to manually adjust the shutter.
4	Capture button	<ul style="list-style-type: none"> • Press and hold to record videos. • Press to capture images.

Figure 2-4 Component description (with LRF)

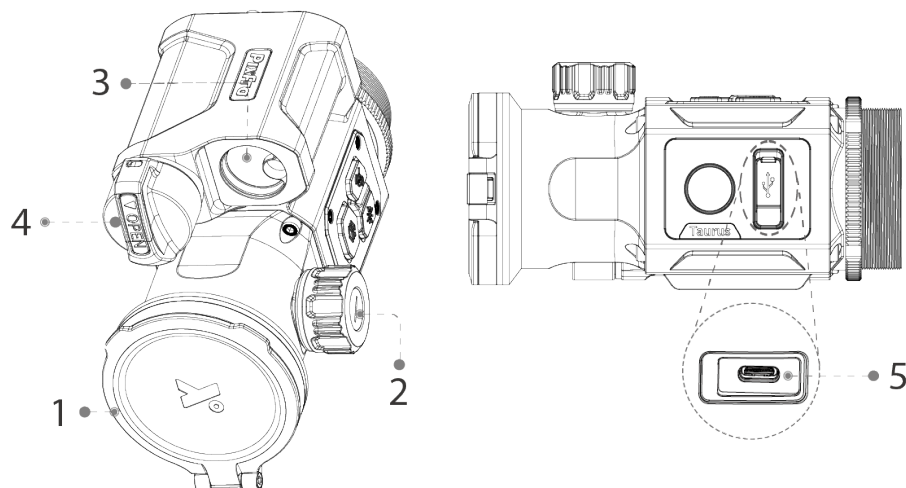

Figure 2-5 Component description (without LRF)

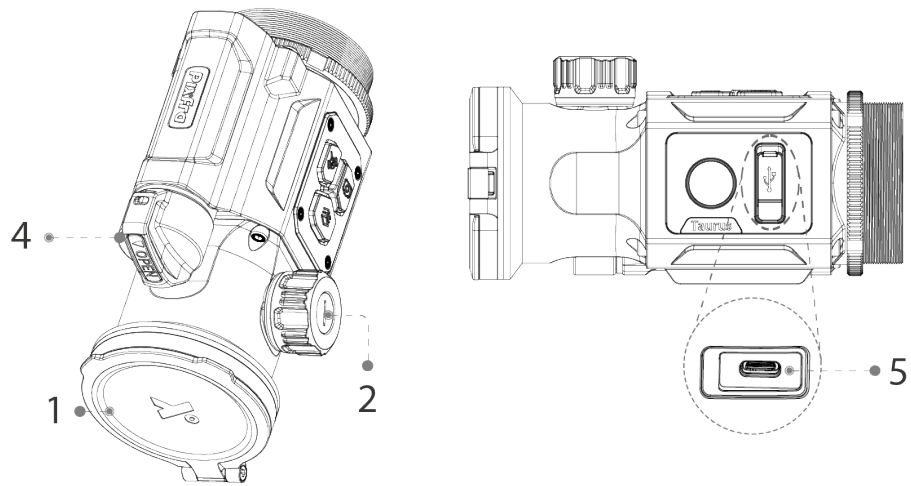



Table 2-3 Component description

No.	Name	Description
1	Protective cover	Dust prevention. Close the cover when not using the Camera.
2	Focus knob	Manually rotate the knob to adjust the focus for a clear image.
3	Laser module	<p>Measures the distance between the Camera and the target.</p> <p> This function is only supported by the Camera with LRF.</p> <p> DANGER Laser can cause damages to eyes. Do not look directly at the laser beam or observe the beam with optical devices when the laser is on.</p>
4	Battery compartment	The place for holding the battery.
5	Type-C port	<ul style="list-style-type: none"> • Connects to a data cable for charging. • Connects to the Camera to a computer for exporting files.

3 Basic Operation

3.1 Starting and Shutdown

Press and hold the power button to start or shut down the Camera; press the power button to suspend the Camera.



After starting the Camera, remove the protective cover of the lens.

- When the Camera is off, press and hold the power button to start it.
- When the Camera is on, press and hold the power button to shut down it.
- When the Camera is on, double-press the power button to suspend the Camera.
- When the Camera is in suspend mode, press the power button to weak up it.

3.2 Image Adjustment

3.2.1 Adjusting Focus

Manually rotate the focusing ring to adjust the focus for a clear image.

Step 1 Aim the thermal lens to the target.

Step 2 Adjust clockwise or counterclockwise the focusing ring until the view is clear.



During the adjustment, do not touch the lens to avoid smudging it; otherwise it may affect the image quality.

Figure 3-1 Adjust focusing

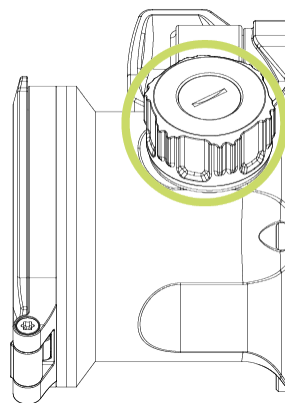

3.2.2 Setting Color Palettes

Select the color palettes, which adds color to the thermal image and uses color to indicate the temperature.

Step 1 Press  to go the brief menu.

Step 2 Press  to select .

Step 3 Press  or  to select the color palettes.



For the camera with LRF, press  or  to select the color palettes.

- White Hot (WH): The objects with high temperature are white. The higher the temperature, the brighter the color.
- Sepia (SP): The objects with high temperature are amber. The higher the temperature, the brighter the color.
- Green Hot (GH): The objects with high temperature are green. The higher the temperature, the brighter the color.
- Alarm (AM): The objects with high temperature are red. The objects can stand out.
- Iron Red (IR): The objects with high temperature are red. The higher the temperature, the brighter the color.
- Black Hot (BH): The objects with high temperature are black. The higher the temperature, the darker the color.

Figure 3-2 White hot



Figure 3-3 Sepia



Figure 3-4 Green hot



Figure 3-5 Alarm



Figure 3-6 Iron red



Figure 3-7 Black hot





3.2.3 Setting Brightness

Adjusts the overall screen brightness. The higher the level is, the brighter the screen will be.

Step 1 Press  to go to the brief menu.

Step 2 Press  to select .

Step 3 Press  or  to set the brightness level. The higher the level is, the brighter the screen will be.





For the camera with LRF, press  or  to select the color palettes.

3.2.4 Setting Contrast

Adjusts the contrast of the picture. The higher the level is, the more the contrast will be between bright and dark areas.

Step 1 Press  to go to the brief menu.

Step 2 Press  to select .

Step 3 Press  or  to set the contrast level. The higher the level is, the more the contrast will be between bright and dark areas.





For the camera with LRF, press  or  to select the color palettes.

3.2.5 Setting Sharpness

Adjusts the sharpness of picture edges. The higher the level is, the clearer the picture edges will be.

Step 1 Press and hold  to go to the standard menu.

Step 2 Press  to select .

Step 3 Press  or  to set the sharpness level. The higher the level is, the clearer the picture

edges will be.



For the camera with LRF, press or to select the color palettes.

3.3 Configuring the Camera

3.3.1 Menu Description

When the Camera is on, press and hold to go to the standard menu. Functions of all buttons are as follows.

- Press or to move upward or downward the cursor.



For the camera with LRF, press or to select the color palettes.

- Press to set the parameters and confirm.
- Press and hold to exit and save the configuration.

3.3.2 Brief Menu

Press to go to the brief menu. You can set color palettes, brightness, contrast, and sharpness.





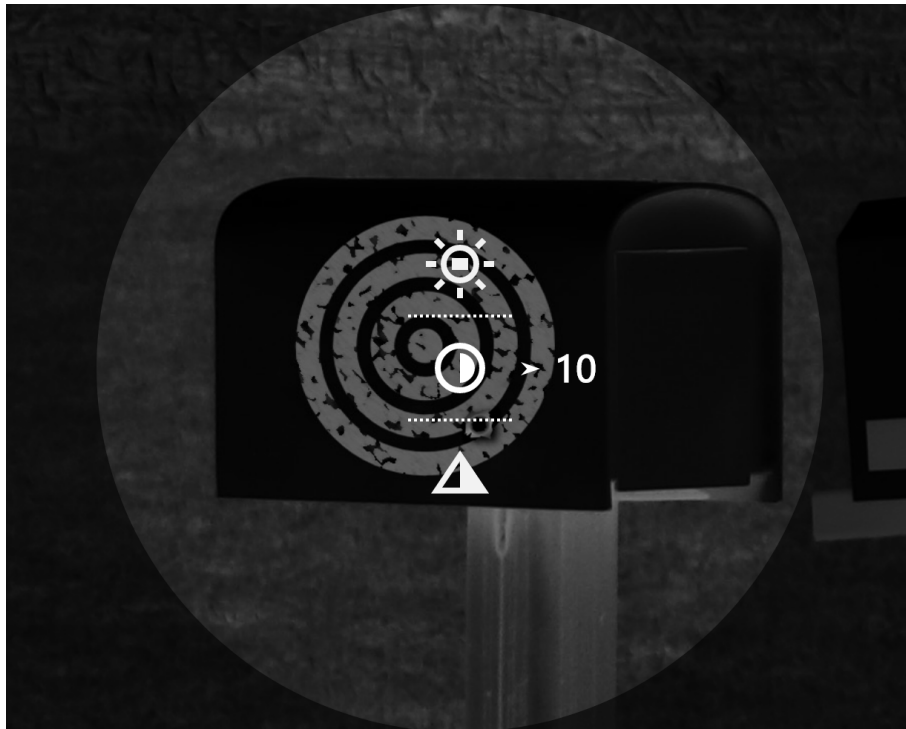



Step 1 Press to go to the brief menu.

Figure 3-8 Brief menu



Step 2 Press to select the parameters to be configured.

Table 3-1 Brief menu

Parameters	Description
Color palettes 	Press  to select the color palettes, which adds color to the thermal image and uses color to indicate the temperature.
Contrast 	Press  to select the contrast level.
Brightness 	Press  to select the brightness level.
Sharpness 	Press  to select the sharpness level.

Step 3 Press and hold  to exit and save the configuration.

3.3.3 Standard Menu

3.3.3.1 Setting Forest Mode

Step 1 Press and hold  to go to the standard menu.

Step 2 Press  or  to select .

Step 3 Press  to enable or disable the forest mode.

- ON: forest mode. Stands out the targets with high temperature, which makes it easier to find out the targets.
- OFF: standard mode. Used for daily observation.

3.3.3.2 Setting Wi-Fi Connection

After enabling Wi-Fi connection, you can connect your phone to the hotspot of the Camera, and then access the Camera with the app.

The frequency bands and modes and the nominal limits of transmitted power (radiated and/or conducted) applicable to this radio device are the following:

Wi-Fi 2.4 GHz (2.4 GHz to 2.4835 GHz)	20 dBm
---------------------------------------	--------







Some cameras will automatically disable the Wi-Fi function when the battery level is lower than 15%.

Step 1 Scan the QR code with your smart phone to install the app.

Figure 3-9 QR code







Step 2 Press and hold  to go to the standard menu.

- Step 3** Press  or  to select .
- Step 4** Press  to enable the Wi-Fi function.
- Wi-Fi name: Model number + serial number.
 - Wi-Fi password: 12345678.
- Step 5** Log in to the app.
Add access devices according to the prompt.







3.3.3.3 Setting Hot Point

Tracks the point with the highest temperature in real time.

- Step 1** Press and hold  to go to the standard menu.
- Step 2** Press  or  to select .
- Step 3** Press  to enable or disable the hot point.
After enabling the hot point, the hot point icon will automatically locate at the points with the highest temperature in the image.





3.3.3.4 Setting Auto FFC

With FFC (Flat-Field Calibration), the thermal image can be optimized, and you can easily find out temperature changes.

- Step 1** Press and hold  to go to the standard menu.
- Step 2** Press  or  to select .
- Step 3** Press  to enable or disable the auto FFC function.
- Enable: The camera calibrates image automatically every certain period.
 - Disable: On the viewing screen, double-press  to manually calibrate the image.

3.3.3.5 Setting Auto Record

After enabling the auto record function, the camera will automatically record the video when the impact sensor of the Camera detects impact.

- Step 1** Press and hold  to go to the standard menu.
- Step 2** Press  or  to select .
- Step 3** Press  to enable or disable the auto record function.





3.3.3.6 Setting DPC



After enabling DPC (Defective Pixels Correction), you can correct the defective pixels in the image.

Prerequisites

Before doing DPC, make sure that you have closed the lens cover.

Procedure





- Step 1** Press and hold  to go to the standard menu.
- Step 2** Press  or  to select .
- Step 3** Press  to go to the DPC mode configuration screen.

- Step 4 Press  to do DPC.
The Camera automatically corrects the defective pixels in the image.
- Step 5 Press  to save the configuration.

3.3.3.7 Setting Menu Size

Set the menu size to fit different day sights.

Procedure

- Step 1 Press and hold  to go to the standard menu.
- Step 2 Press  or  to select .
- Step 3 Press  to toggle the menu sizes.

3.3.3.8 Setting Zeroing

Prerequisites

Before setting zeroing, make sure that you have selected the zeroing group in **Zeroing Profile**. For details, see "3.3.3.9 Setting Zeroing Profile".

Procedure















- Step 1 Press and hold  to go to the standard menu.
- Step 2 Press  or  to select .
- Step 3 Press  to go to the zeroing configuration screen.
- Step 4 Do zeroing.
- 1) Press  or  to select  and press  to freeze the image.
 - 2) Select  and press  to select X-axis and Y-axis.
 - 3) Press  or  to adjust the position of the screen until the target (the red dot in Figure 3-10) coincides with the reticle center of the day sight.
 - 4) Select  and then then press  to save the configuration.

Figure 3-10 Zeroing





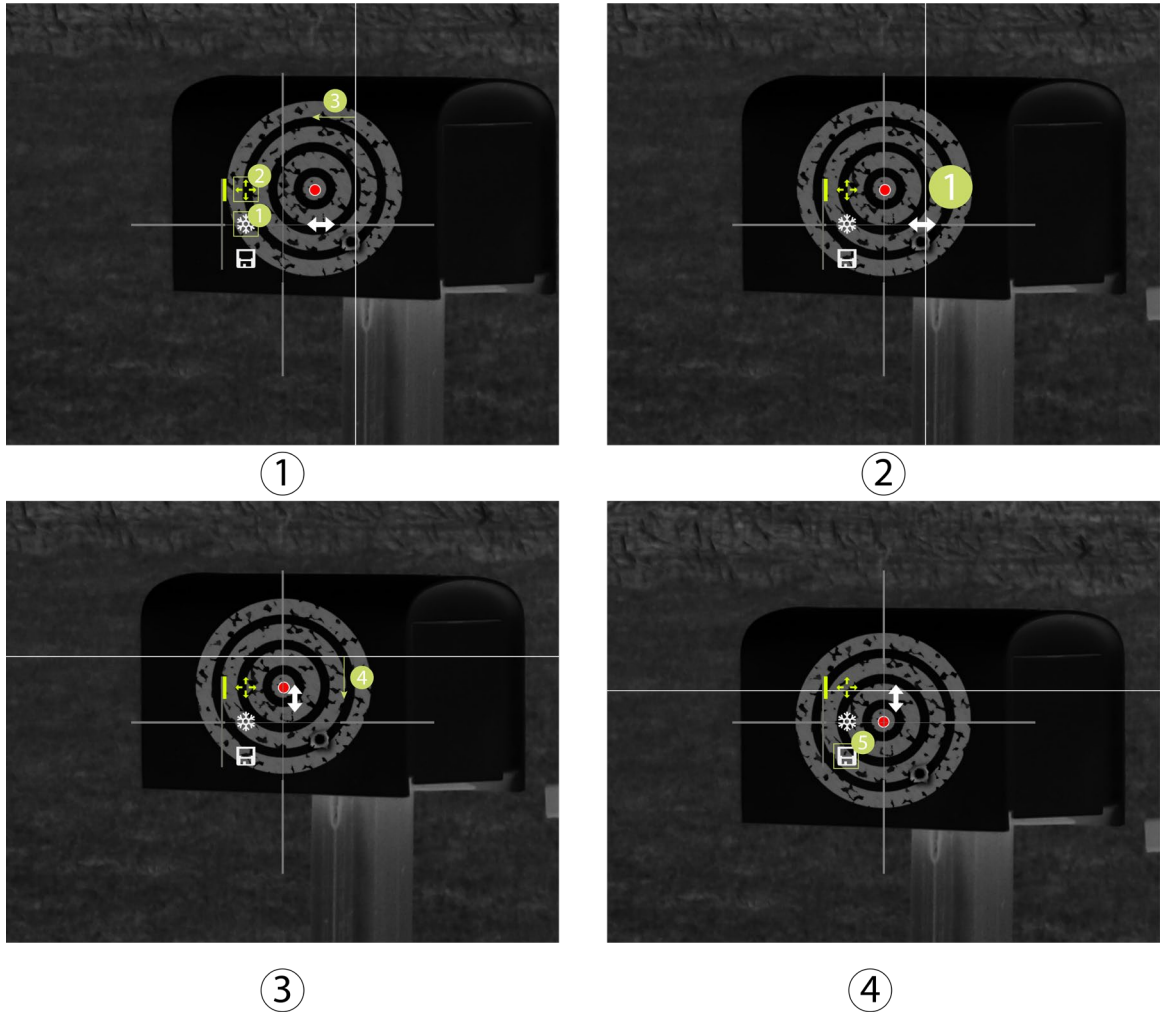

3.3.3.9 Setting Zeroing Profile

Prerequisites

Before setting zeroing profile, make sure that you have configured zeroing in **Zeroing**. For details, see "3.3.3.8 Setting Zeroing".

Procedure

- Step 1** Press and hold  to go to the standard menu.
- Step 2** Press  or  to select .
- Step 3** Press  to select the zeroing profile as needed.



The Camera supports multiple zeroing profiles.

3.3.3.10 Setting Ranging Mode

After setting the ranging mode, the Camera can measure the range towards targets.



To guarantee the measurement accuracy, keep your hand steady when measuring the range.

- Step 1** Press and hold  to go to the standard menu.

Step 2 Press  or  to select .

Step 3 Press  to enter the ranging mode.

Step 4 Press  to move the green lines to the top and bottom of the target to get the distance between the target and the Camera.

Use the following figure as an example:

- If the target is a wolf, it is 30 m away from Camera.
- If the target is a rabbit, it is 11 m away from Camera.
- If the target is a wild boar, it is 33 m away from Camera.
- If the target is a deer, it is 48 m away from Camera.

Figure 3-11 Ranging Mode



3.3.3.11 Setting Laser Ranging



DANGER

Laser can cause damages to eyes. Do not look directly at the laser beam or observe the beam with optical devices when the laser is on.

3.3.3.11.1 Measurement Considerations

Measurement targets

The Camera is suitable for measuring the distance between the camera and the targets with high reflectivity (such as road signs on highways), the targets with moderate reflectivity (such as wall) and the targets with low reflectivity (such as tree, golf flag, utility pole, and animal). When the reflectance is reduced to a certain extent, the range will be reduced accordingly.

Factors that influence ranging capability

- Target reflectivity: Generally, the higher the reflectivity of the target, the better the ranging ability. For example, the measuring range of the Camera is 1,500 m for a target with moderate reflectivity, which can be up to 1,800 m for a target with high reflectivity, and 600 m for the

targets with low reflectivity. (It might fail to measure the target that hardly generates diffuse reflection, such as water surface.)

- Target shape: When a target is too small or uneven, the ranging ability will decrease.
- Measuring angle: The measurement is more accurate when the reflection surface of target is vertical to the laser emission's direction. If you use the Camera under some extreme conditions, the measurement might be inaccurate.
- Measuring environment: The environment factors include sunshine intensity, the concentration of water vapor in the air and suspended particles (such as rain, fog, snow, fog and haze).

The range ability of the Camera defined under the following conditions:

- The measurement target is with moderate reflectivity, such as walls.
- The reflection surface of target is vertical to laser emission direction.
- The weather condition is sunny but not under the condition of direct sunlight.

3.3.3.11.2 Setting Laser Ranging Mode

After setting the laser ranging mode, the Camera can measure the range towards targets.



To guarantee the measurement accuracy, keep your hand steady when measuring the range.

Step 1 Press and hold to go to the standard menu..

Step 2 Press or to select .

Step 3 Press to select the laser ranging mode.

- Once: After pressing the laser button, the Camera measures the distance between the camera and the target once.
- Continue: After pressing the laser button, the Camera continuously measures the distance between the Camera and the target in 15 s.

3.3.3.12 System Settings

Step 1 Press and hold to go to the standard menu.









Step 2 Press or to select .

Step 3 Press to go to the **System Setting** screen..

Step 4 Press or to select the parameter to be configured.

Table 3-2 System settings

Parameter	Description
Language	Press to select the language as needed.
USB Mode	Press to select the USB mode. <ul style="list-style-type: none"> • Storage: The Camera can be used as a storage device. • OFF: Charge the Camera.
Time Set	Press to select the time to be configured. Press to select year, month, day, hour or minute, an then press to set the value.
Power Indicator	Press to select the brightness level of power indicator.

Parameter	Description
Burning Warning 	Press  to enable the burning warning function. When the lens is in the risk of burning, a note will be displayed on the screen and the shutter will be off automatically.
Logo 	Press  to enable logo display, and the logo will be display on the left lower corner of the screen.
Unit Set 	Press  to select the unite from m and yd .
MIC 	Press  to enable or disable the microphone. <ul style="list-style-type: none"> ● On: The videos are recorded with sound. ● Off: The videos are recorded without sound.

3.3.3.13 Viewing the Version

Step 1 Press and hold  to go to the standard menu.

Step 2 Press  or  to select .

Step 3 Press  to view the device information.

3.3.3.14 Restoring Default

Step 1 Press and hold  to go to the standard menu.

Step 2 Press  or  to select .

Step 3 Press  to restore the parameters to the defaults.

3.4 Video and Snapshot

3.4.1 Recording Videos

3.4.1.1 Auto Recording



After enabling the auto record function, the camera will automatically record the video when the impact sensor of the Camera detects impact.

Step 1 Press and hold  to go to the standard menu.

Step 2 Press  to select .

Step 3 Press  to enable or disable the auto record function.

3.4.1.2 Recording Videos

On the viewing screen, press and hold  for 3 seconds to start recording a video. The green icon  and the recording time is display.



For the camera with LRF, press  for 3 seconds to start recording a video.

Press and hold  again for 3 seconds to stop the recording. When the recording stops, the recording time will display normally.

3.4.2 Capturing Images

On the viewing screen, press  to capture images.

The screen will display an icon when the capturing succeeds.



For the camera with LRF, press  and  at the same time to start capture images.

3.4.3 Exporting File

Exports the recorded and captured files.

Step 1 Connect the Camera to the computer through Type-C data cable.

The driver will automatically be installed for first-time connection.



- Connect the cables before starting the Camera. Do not hot swap the Type-C port of the Camera.
- Select **Storage** on the **USB Mode** configuration screen after connecting the Camera to the computer.

Step 2 On the computer desktop, double-click **My Computer**, and then open the Camera disk at a mobile storage device.

Step 3 Select the files to export and copy them to the computer.

The specific computer client is required for playing the exported files.

Step 4 Disconnect the Type-C data cable with the computer.

After connecting the Camera to the computer, images can be displayed on the Camera, but the functions of recording and capturing will not be available.

3.5 Power Supply

You can supply power to the Camera through the rechargeable battery coming with the Camera or charging with the Type-C cable.

3.5.1 Installing the Battery

Step 1 Open the cover of the battery compartment.

Step 2 Put one battery into the battery compartment.



Make sure that the battery is installed with the positive electrode downward.

Step 3 Tighten the cover.

3.5.2 Charging

The start bar will display battery information after the Camera starts. When the battery is low, charge the Camera timely to make sure the normal function.

- During charging, keep the battery temperature 0 °C to +60 °C (+32 °F to +140 °F).
- Charge the Camera with the data cable that comes with the delivery.

Step 1 Open the sealing cover of the port when charging.

Step 2 Connect the Type-C cable to the port to charge the Camera.







The charging indicator states:

- Red and green lights flashing alternately: charging error.
- Red light on: charging.
- Green light on: fully charged.
- Off: not connected to data cable to charge.

4 System Update

Update the Camera manually or through the app.

4.1 Upgrading Manually

- Step 1 Press and hold  to go to the standard menu.
- Step 2 Press  to select .
- Step 3 Press  to go to the **System Setting** configuration screen.
- Step 4 Press  to select .
- Step 5 Press  to select **Storage** in **USB Mode**.
- Step 6 Copy the upgrading file (.bin).
- Step 7 Restart the Camera.

4.2 Upgrading through App

When the app detects new program for upgrading, it will prompt a notification. Tap **Upgrade** to upgrade the system.

Appendix 1 Compliance Notice

The thermal series products might be subject to export controls in various countries or regions, including without limitation, the United States, European Union, United Kingdom and/or other member countries of the Wassenaar Arrangement. Please consult your professional legal or compliance expert or local government authorities for any necessary export license requirements if you intend to transfer, export, re-export the thermal series products between different countries.