

User Manual

Thermal Monocular

CONDOR LRF 2.0 SERIES

V5.5.118 202412



Contact Us

CONTENTS

1	Overview	1
1.1	Device Description.....	1
1.2	Main Function.....	1
1.3	Appearance.....	1
2	Preparation	4
2.1	Install Battery.....	4
2.1.1	Battery Instruction	4
2.1.2	Battery Installation.....	4
2.2	Cable Connection.....	5
2.3	Attach Neck Strap.....	5
2.4	Attach Hand Strap	6
2.5	Use Carrying Bag	7
2.6	Power On/Off	8
2.7	Auto Screen Off.....	9
2.8	Menu Description	9
2.9	App Connection	10
2.10	Firmware Status	11
2.10.1	Check Firmware Status	11
2.10.2	Upgrade Device.....	11
3	Image Settings	13
3.1	Adjust Diopter	13
3.2	Adjust Focus.....	13
3.3	Adjust Brightness	14
3.4	Adjust Contrast.....	14
3.5	Adjust Tone.....	14
3.6	Adjust Sharpness	15
3.7	Select Scene Mode	16
3.8	Set Palettes.....	16
3.8.1	Custom Enabled Palettes.....	16
3.8.2	Switch Palettes	17
3.9	Adjust Digital Zoom.....	19
3.10	Set Picture in Picture Mode.....	19
3.11	Zoom Pro	20
3.12	Flat Field Correction	20
3.13	Correct Defective Pixel	21
4	Measure Distance.....	22
5	General Settings.....	24
5.1	Set OSD	24
5.2	Set Screen Style.....	24
5.3	Set Brand Logo	24
5.4	Burning Prevention	25
5.5	Hot Tracking	25
5.6	Capture and Video	26
5.6.1	Capture Picture	26

Thermal Monocular User Manual

5.6.2	Set Audio	26
5.6.3	Record Video	26
5.6.4	View Local Album.....	27
5.7	Export Files	28
5.7.1	Export Files via HIKMICRO Sight.....	28
5.7.2	Export Files via PC.....	29
6	System Settings	30
6.1	Adjust Date	30
6.2	Adjust Time.....	30
6.3	Set Language.....	30
6.4	Cast Device Screen to PC.....	31
6.5	Set Unit.....	31
6.6	Save Diagnostic Log.....	31
6.7	View Device Information	32
6.8	Restore Device.....	32
6.9	Reset Device	32
7	Frequently Asked Questions	33
7.1	Why does the charge indicator flash improperly?.....	33
7.2	Why is the power indicator off?.....	33
7.3	The image is not clear, how to adjust it?	33
7.4	Capturing or recording fails. What's the problem?.....	33
7.5	Why the PC cannot identify the device?	33

1 Overview

1.1 Device Description

HIKMICRO CONDOR LRF 2.0 series is a powerful and innovative thermal monocular equipped with a high-end infrared detector. The device can be mainly applied in the forest & field hunting, birding, animal searching, adventuring, and rescuing scenario regardless of light and weather conditions.

- With less than 15 mK NETD and shutterless image system, it ensures a seamless observing experience of ultra-clear image quality and detail recognition without being disturbed by the shutter.
- Powered with its 1000 m laser rangefinder, it can accurately measure the distance under any condition.

1.2 Main Function

- **Zoom Pro:** An advanced zoomed image processing algorithm, ensures maximum image optimization under digital zoom.
- **HSIS (HIKMICRO Shutterless Image System):** It is a dynamic learning process without image quality loss. This eliminates the need for periodic calibration pauses, ensuring you never miss a critical moment in the field.
- **Local Album:** Local album stores captured images and videos, which help you clarify whether you get the game immediately.
- **Distance Measurement:** The device can measure the distance between the target and observation position.
- **Auto Screen Off:** The function allows the device to enter standby mode/wake up through angle changes. The function darkens the screen to save energy and extend battery life.
- **App Connection:** The device can capture snapshots, record videos, and set parameters by HIKMICRO Sight app after being connected to your phone via hotspot.

1.3 Appearance



Note

- The appearance may vary according to different models. Please take the actual product for reference.
-

Thermal Monocular User Manual

- Pictures in this manual are for illustration purpose only. Please take the actual product for reference.

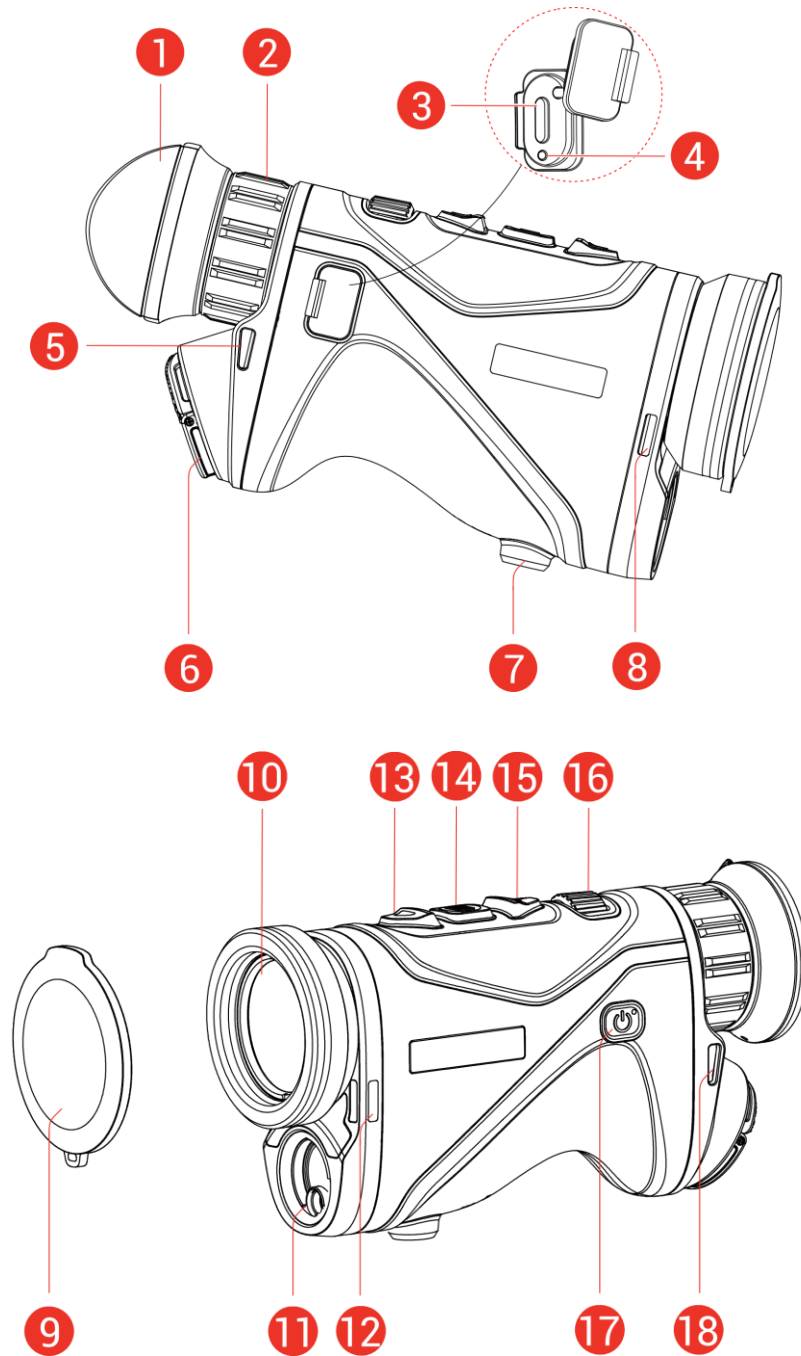





Figure 1-1 Appearance

Table 1-1 Component Descriptions

No.	Component	Description
1	Eyepiece	The piece placed closest to the eye to view the target.
2	Diopter Adjustment Ring	Adjusts the dioptic setting.

Thermal Monocular User Manual

No.	Component	Description
3	Type-C Interface	To connect the device to power supply or transmit data with a type-C cable.
4	Charging Status Indicator	<ul style="list-style-type: none"> ● Flashing Red & Green: Error occurred. ● Solid Red: Charging. ● Solid Green: Fully charged.
5, 8, 12, 18	Strap Attachment Point	Attaches the neck strap or hand strap.
6	Battery Compartment	For holding the battery.
7	Tripod Mount	Mounts the tripod.
9	Lens Cover	Protects the lens from dust or scratch.
10	Thermal Lens	For thermal imaging.
11	Laser Range Finder	Measures the distance to the target with laser.
13	 Up Key	Non-Menu Mode: <ul style="list-style-type: none"> ● Press: Turn on laser ranging. ● Double-Press: Turn off laser ranging. ● Hold: Start/Stop recording videos. Menu Mode: Move up.
14	 Mode Key	Non-Menu Mode: <ul style="list-style-type: none"> ● Press: Switch palettes. ● Hold: Enter the menu. Menu Mode: <ul style="list-style-type: none"> ● Press: Confirm/Set parameters. ● Hold: Save and exit menu.
15	 Down Key	Non-Menu Mode: <ul style="list-style-type: none"> ● Press: Switch digital zoom. ● Hold: Correct non-uniformity of display (FFC). Menu Mode: Move down.
16	Focus Knob	Adjusts focus to obtain clear targets.
17	 Power Key	<ul style="list-style-type: none"> ● Press: Standby mode/Wake up device. ● Hold: Power on/off.
13 + 14	Up Key + Mode Key	Press to capture snapshots.



Note

- The power indicator stays solid red when the device is on.
 - When the auto screen off function is enabled, if you press  to enter standby mode, you can also tilt or rotate the device to wake up the device. Refer to **Auto Screen Off** for detailed operation.
-

2 Preparation

2.1 Install Battery

2.1.1 Battery Instruction

- The device supports removable Li-ion 21700 battery, and the battery size should be 22.3 mm × 76 mm. The battery rated voltage and capacity is 3.59 V/5500 mAh.
- To ensure better conductivity, if the battery compartment cover gets dirty, use a clean cloth to wipe the thread.
- Charge the battery with battery charger for more than 4 hours before first use.
- Remove the battery if the device is not used for a long time.

2.1.2 Battery Installation

Insert the battery into the battery compartment.

Steps

1. Lift the pull tab (1), and rotate the battery compartment cover counterclockwise (2) to loosen it.

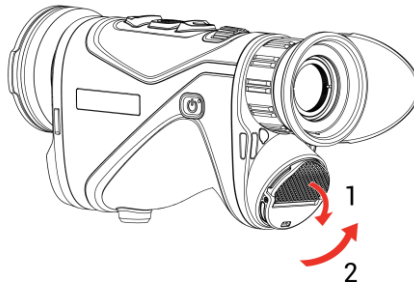

Figure 2-1 Open the Battery Compartment Cover

2. Insert the battery into the battery compartment as the positive and negative marks indicate.

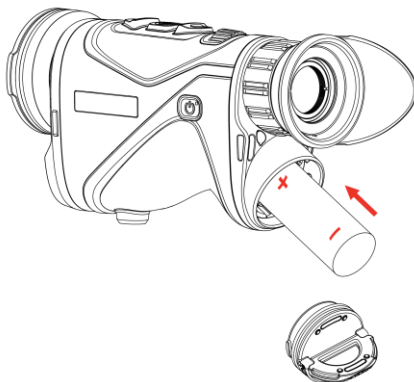

Figure 2-2 Insert the Battery

3. Insert the battery compartment cover (3) and rotate it clockwise (4) until it is tight and locked.

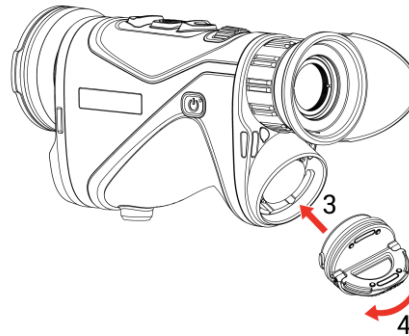

Figure 2-3 Close the Cover

2.2 Cable Connection

Steps

1. Lift the type-C interface cover.
2. Connect the device and power adapter with a type-C cable to charge the device. Alternatively, connect the device and PC to export files.

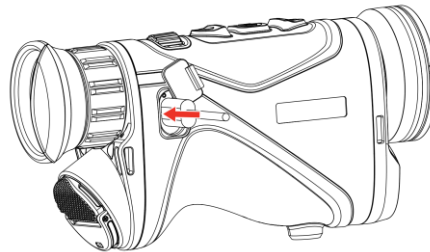

Figure 2-4 USB Connection

Figure 2-5



Note

- Please charge the device after the battery is installed in the battery compartment of the device.
 - The charging temperature should be from 0 °C to 50 °C (32 °F to 122 °F).
 - You can use battery charger to charge the battery.
 - If the battery is not used for a long time, please charge it with a battery charger before use. In this situation, type-C charging for the device is not supported.
-

2.3 Attach Neck Strap

Steps

1. Thread one end of the neck strap through a neck strap attachment point.

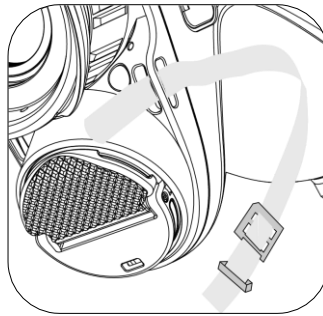

Figure 2-6 Thread Neck Strap through Attachment Point

2. Thread the neck strap through the strap buckle and fasten the neck strap, as is shown in the picture.

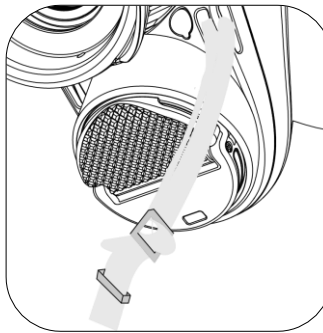

Figure 2-7 Thread Neck Strap through Strap Buckle

3. Thread the neck strap through the strap keeper.

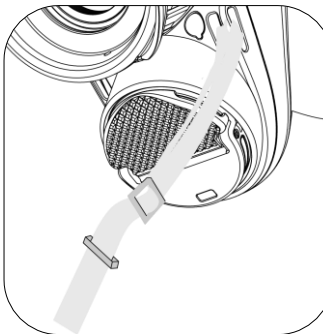

Figure 2-8 Thread Neck Strap through Strap Keeper

4. Repeat above steps to finish mounting, and adjust the length of neck strap as needed.

2.4 Attach Hand Strap

Steps

1. Slide one end of the hand strap through the attachment point.

2. Thread the hand strap through the hand strap buckle, and fasten the hand strap to secure it.
3. Repeat above steps to finish mounting.
4. Adjust the tightness of the hand strap as needed.

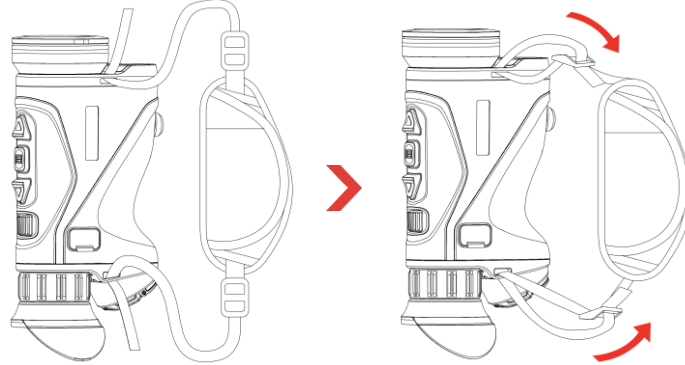

Figure 2-9 Attach Hand Strap

2.5 Use Carrying Bag

The carrying bag comes a safety strap and MOLLE system for comfortable carrying and ensures the device safety. You can adjust the length of the strap according to your preference. The bag can be carried with flexible options:

- The carrying bag is equipped with 4 attachment rings, so you can attach the safety strap to the bag as a sling bag or neck pouch.

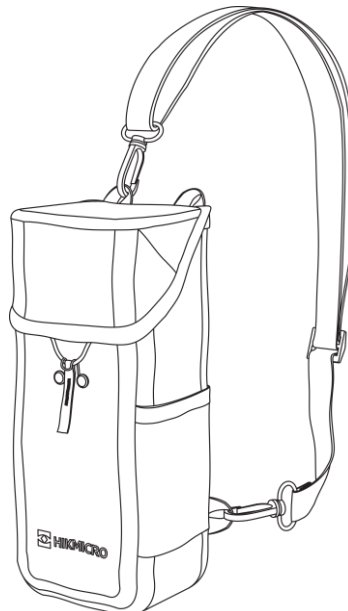

Figure 2-10 Attach the Safety Strap to the Bag

- The carrying bag can be attached to other MOLLE-compatible backpack using the MOLLE straps for extra carrying capacity and easy access.
- The carrying bag can be attached to a tactical belt or a regular one as a waist pack.

2.6 Power On/Off

Power On

When the battery is sufficiently charged, hold  to power on the device.

Power Off

When the device is turned on, hold  to power off the device.











Note

- Power-off countdown will appear when you power off the device. You can press any key to interrupt the countdown and cancel the power-off.
 - Automatic low battery power-off cannot be canceled.
-

Auto Power Off



You can set the auto power off time for your device.

Steps

1. Hold  to show the menu.
 2. Go to  **Advanced Settings**, and press  or  to select .
 3. Press  or  to select the auto power off time as needed, and press  to confirm.
 4. Hold  to save the settings and exit.
-



Note









- See the battery icon for the battery status.  means the battery is fully charged,  means that the battery is low, and  means the battery charging is abnormal.
 - When the low power note shows, charge the battery.
 - The auto power off takes effect only when the device isn't in operation or connected with HIKMICRO Sight app.
-

- The auto power off countdown will start again when the device exits standby mode, or the device is restarted.
-

2.7 Auto Screen Off

Auto screen off function darkens the screen to save energy and extend battery life.

Steps

1. Enable auto screen off.
 - 1) Hold  to show the menu.
 - 2) Go to  **Advanced Settings**, and press  or  to select .
 - 3) Press  to enable auto screen off.
 - 4) Hold  to save settings and exit.
2. The device will enter standby mode under one of the following operations when the display is turned on:
 - Tilt the device downwards from 70° to 90°.
 - Rotate the device horizontally from 75° to 90°.
 - Keep the device still and do not move it for 5 minutes.
3. You can wake up the device by one of the following operations when the display is turned off:
 - Tilt the device downwards from 0° to 60° or upwards from 0° to 90°.
 - Rotate the device horizontally from 0° to 75°.
 - Press  to wake up the device.





Note

After enabling the auto screen off, when you enter the menu, the auto screen off does not take effect until you exit the menu.

2.8 Menu Description

In the live view interface, hold  to show the menu.

- Press  to move up.
- Press  to move down.
- Press  to confirm and hold it to exit the menu.

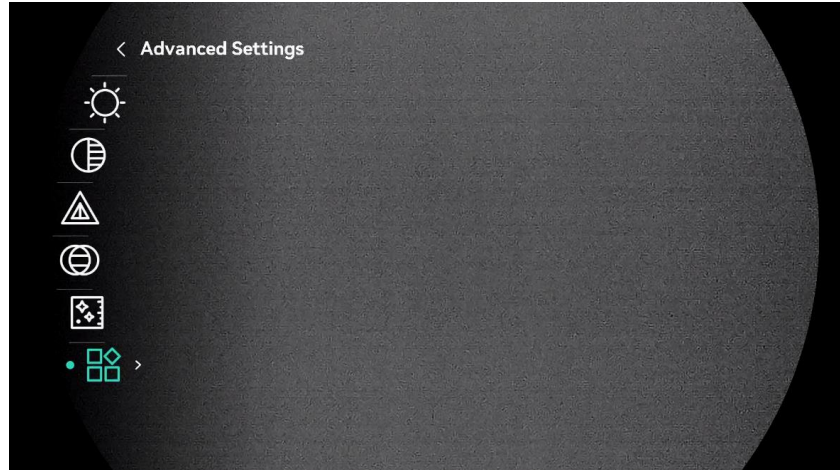

Figure 2-11 Device Menu (Round Screen Style)

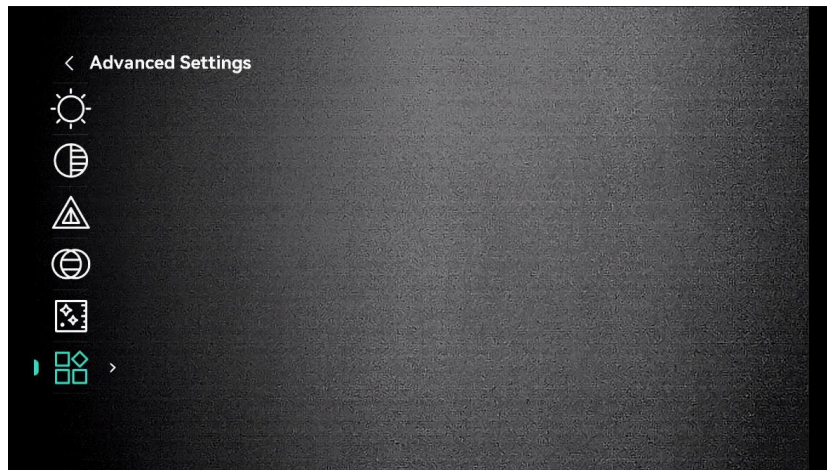

Figure 2-12 Device Menu (Square Screen Style)

2.9 App Connection

Connect the device to the HIKMICRO Sight app via hotspot, and then you can capture picture, record video, or configure parameters on your phone.

Steps

1. Search the HIKMICRO Sight app on App Store (iOS System) or Google Play™ (Android System) to download it, or scan the QR code to download and install the app.





Android System



iOS System

2. Hold  to show the menu.

3. Go to  **Advanced Settings**, and press \triangle or ∇ to select .
4. Press  to enter the setting interface.
5. Press \triangle or ∇ to select **Hotspot_2.4G** or **Hotspot_5G**. The hotspot function is enabled and the hotspot password is displayed.
6. Turn on the WLAN of your phone and connect to the hotspot.
 - Hotspot Name: HIKMICRO_Serial No.
 - Hotspot Password: Go to **Hotspot** in the menu to check the password.
7. Open the app and connect your phone with the device. You can view the interface of device on your phone.



Note

The device cannot connect to the app if entering wrong password several times. Refer to **Reset Device** to reset the device, and connect the app again.

2.10 Firmware Status

2.10.1 Check Firmware Status

Steps

1. Open the HIKMICRO Sight and connect your device to the app.
2. Check if there is an upgrade prompt on the device management interface. If there is no upgrade prompt, the firmware is the latest version. Otherwise, the firmware is not the latest version.

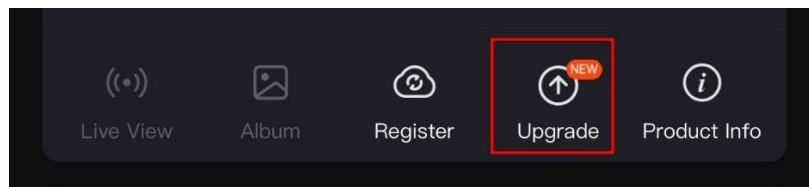

Figure 2-13 Check Firmware Status

3. (Optional) If the firmware is not the latest version, upgrade the device. See **Upgrade Device**.

2.10.2 Upgrade Device

Upgrade Device via HIKMICRO Sight

Steps

1. Open HIKMICRO Sight app and connect your device to the app.

2. Tap the upgrade prompt to enter the firmware upgrade interface.
3. Tap **Upgrade** to start upgrade.



Note









The upgrading operation may vary due to app updates. Please take the actual app version for reference.

Upgrade Device via PC

Before You Start

Please get the upgrade package first.

Steps

1. Hold  to show the menu.
 2. Go to  **Advanced Settings**, and press  or  to select .
 3. Press  to enter the configuration interface.
 4. Press  or  to select **USB Flash Drive**.
 5. Connect the device to your PC with the type-C cable.
 6. Open the detected disk, copy the upgrade file and paste it to the root directory of the device.
 7. Disconnect the device from your PC.
 8. Reboot the device, and the device upgrades automatically. The upgrading process will be displayed in the main interface.
-



Caution

During the upgrade package transmission, make sure the device is connected to your PC. Otherwise, it may cause unnecessary upgrade failure, firmware damage, etc.

3 Image Settings

3.1 Adjust Diopter

Make sure the eyepiece covers your eye and aim at the target. Adjust the diopter adjustment ring until the OSD text or image is clear.

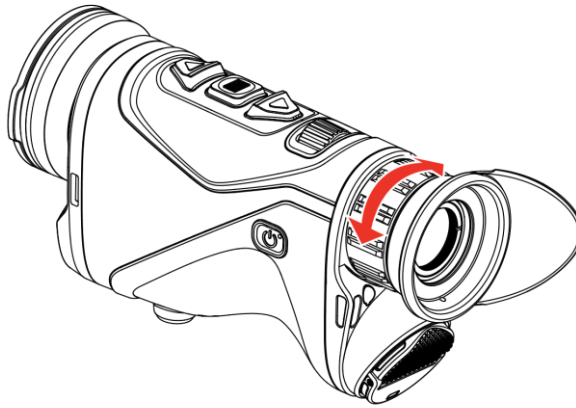

Figure 3-1 Adjust Diopter



Note

When adjusting diopter, DO NOT touch the surface of lens to avoid smearing the lens.

3.2 Adjust Focus

Slightly rotate the focus knob to adjust the focus of the objective lens until the image is clear.

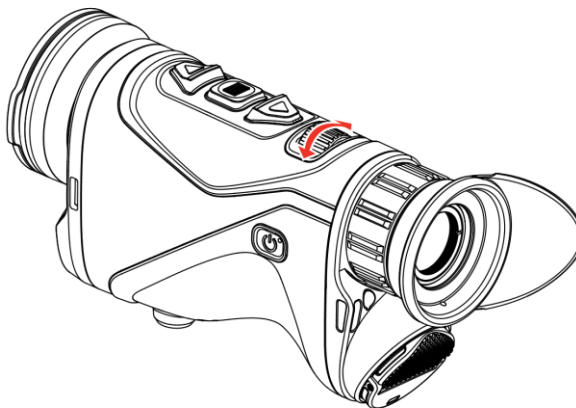

Figure 3-2 Adjust Focus











Note

When adjusting focus, DO NOT touch the surface of lens to avoid smearing the lens.

3.3 Adjust Brightness









You can adjust the brightness of the screen in the menu.

Steps

1. Hold  to show the menu.
2. Press  or  to select  and press  to confirm.
3. Press  or  to adjust display brightness.
4. Hold  to save the settings and exit.

3.4 Adjust Contrast

Steps

1. Hold  to show the menu.
2. Press  or  to select  and press  to confirm.
3. Press  or  to adjust contrast.
4. Hold  to save and exit.

3.5 Adjust Tone

Steps









1. Hold  to show the menu.
2. Press  or  to select  and press  to confirm.
3. Press  or  to select a tone. **Warm** and **Cold** can be selected.
4. Hold  to save and exit.



Figure 3-3 Adjust Tone

3.6 Adjust Sharpness

Steps









1. Hold  to show the menu.
2. Press  or  to select  and press  to confirm.
3. Press  or  to adjust sharpness.
4. Hold  to save and exit.













Figure 3-4 Sharpness Comparison

3.7 Select Scene Mode

You can select proper scene according to actual using scene to improve the display effect.

Steps









1. Hold  to show the menu.
2. Go to  **Advanced Settings**, select  and press  to confirm.
3. Press  or  to select scene modes, and press  to confirm.
 - **Observation:** Observation mode is recommended in normal scene.
 - **Detection:** Detection mode is recommended in hunting environment.
4. Hold  to save settings and exit.

3.8 Set Palettes

You can select different palettes to display the same scene in different effects.

3.8.1 Custom Enabled Palettes

Steps

1. Hold  to show the menu.
2. Go to  **Advanced Settings**, press  or  to select .
3. Press  to enter the settings interface.
4. Press  or  to select the palettes as needed, and press  to enable them.



Note

At least one palette should be enabled.

5. Hold  to save the settings and exit.

3.8.2 Switch Palettes

Press  in the live view interface to switch the selected palettes.

White Hot

The hot part is light-colored in view. The higher the temperature is, the lighter the color is.



Black Hot

The hot part is black-colored in view. The higher the temperature is, the darker the color is.



Red Hot

The hot part is red-colored in view. The higher the temperature is, the redder the color is.



Fusion

From high temperature to low temperature, the image is colored in from white, yellow, red, pink to purple.



Red Monochrome

The whole image is red colored. The higher the temperature is, the lighter the color is.



Green Monochrome

The whole image is green colored. The higher the temperature is, the lighter the color is.



3.9 Adjust Digital Zoom

You can zoom in and out the image by using this function. Press ∇ in the live view interface to switch the digital zoom ratio switches between 1x, 2x, 4x, and 8x.







Note

- When switching the digital zoom ratio, the left interface displays the actual magnification (Actual Magnification = Lens Optical Magnification \times Digital Zoom Ratio). For example, the lens optical magnification is 2.8x and the digital zoom ratio is 2x, and the actual magnification is 5.6x.
 - The zoom ratio may vary according to different models. Please take the actual product for reference.
-

3.10 Set Picture in Picture Mode

Steps

1. Hold  to show the menu.
2. Go to  **Advanced Settings**, and press \triangle or ∇ to select .
3. Press  to enable this function.

Result

When PIP is turned on, the image center is displayed in upper middle of the interface.



Figure 3-5 Set PIP Mode









Note

- If the PIP function is enabled, only the PIP view zooms when adjusting the digital zoom ratio.
 - The PIP view temporarily displays the zoom ratio when adjusting the digital zoom of the device.
-

3.11 Zoom Pro

Zoom Pro refers to zoomed image detail enhancement. When you turn on this function, the details of zoomed live view image will be enhanced.

Steps

1. Hold  to show the menu.
2. Press  or  to select , and press  to enable it.
3. Hold  to save the settings and exit.

Result

The details of the zoomed live view image will be enhanced.



Note

If the PIP function is enabled, Zoom Pro is only enabled in the PIP view.







3.12 Flat Field Correction

This function can correct non-uniformity of display. Hold  in the live view to correct non-uniformity of display.

3.13 Correct Defective Pixel

The device can correct the defective pixels on the screen which are not performed as expected.

Steps

1. Hold  to show the menu.
2. Go to  **Advanced Settings**, press \triangle or ∇ to select .
3. Press  to enter the DPC setting interface.
4. Press  to select the X or Y axis, and press \triangle or ∇ to set the coordinates until the cursor reaches the dead pixel. If you select X, the cursor moves left and right; if you select Y, the cursor moves up and down.
5. Press  twice to correct the dead pixel.
6. Hold  to save and exit.



Note

- The selected defective pixel can be magnified on the display.
 - If the screen OSD blocks the defective pixel, move the cursor to reach the defective pixel, then the device performs mirror display automatically.
-













4 Measure Distance

The device with an LRF module in the lens can detect the distance between the target and the observation position with laser.

Before You Start

When measuring the distance, keep the hand and the position steady. Otherwise, the accuracy may be affected.

Steps

1. Hold  to show the menu.
2. Go to  **Advanced Settings**, press  and  to select .
3. Press  to go to the measurement interface. Go to  to select a laser ranging mode. Press  to confirm. **Once** and **Continuous** are selectable.
 - **Once**: Measure the distance once.
 - **Continuous**: Measure the distance continuously, and the measurement duration can be selected. The measurement result will be refreshed every second.
4. (Optional) Horizontal distance can also be displayed on the live view interface when performing laser ranging. Select  and press  to enable the horizontal distance.
5. Hold  to save the settings and return to the live view interface.
6. Press  in the live view interface to turn on laser ranging, and aim the cursor at the target and press  again to measure the target distance.



Note

- Double press  in the live view to turn off laser ranging.
 - Laser ranging cannot be enabled when device battery is low.
-

Result

The distance measurement result is displayed near the cursor on the image.

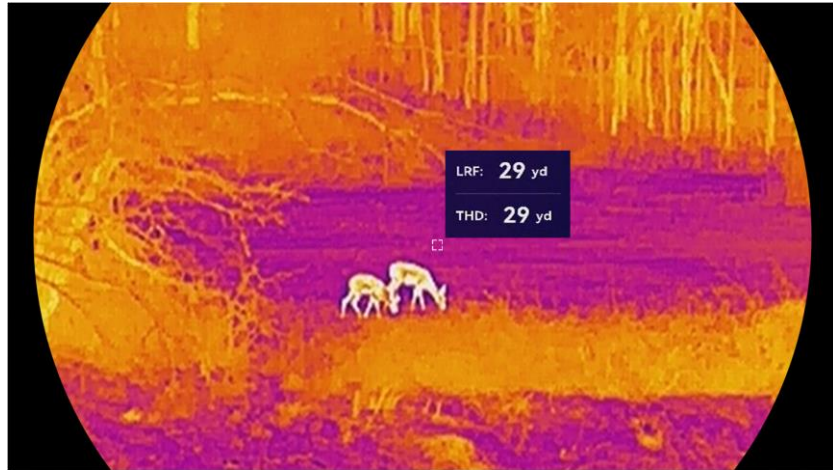

Figure 4-1 Distance Measurement Result

LRF: 29 yd means the straight-line distance, and **THD: 29 yd** means the horizontal distance.



Caution









The laser radiation emitted from the device can cause eye injuries, burning of skin or inflammable substances. Before enabling the laser ranging function, make sure no human or inflammable substances are in front of the laser lens.

5 General Settings

5.1 Set OSD

You can choose whether to display the OSD information on the live view interface.

Steps

1. Hold  to show the menu.
2. Go to  **Advanced Settings**, and select .
3. Press  to enter OSD setting interface.
4. Press  and  to select the **Time, Date, or OSD**, and press  to turn on or turn off the selected OSD information.
5. Hold  to save and exit.











Note

If you turn off **OSD**, all OSD information on the live view will not be displayed.

5.2 Set Screen Style

You can select screen style according to your preference.





Steps

1. Hold  to show the menu.
2. Go to  **Advanced Settings**, and press  or  to select .
3. Press  to confirm. Press  or  to select screen style modes. **Round** and **Square** are selectable.
4. Hold  to save according to the prompt. The device will be rebooted.

5.3 Set Brand Logo

You can add brand logo to the live view interface, snapshots, and videos.

Steps

1. Hold  to show the menu.
2. Go to  **Advanced Settings**, and select .
3. Press  to enable or disable **Brand Logo**.

4. Hold  to save the settings and exit.





Result

The brand logo is displayed at the bottom left of the image.

5.4 Burning Prevention

Avoid direct sunlight and enable the Burning Prevention function to reduce the risk of sensor damage from the heat.





Steps

1. Hold  to show the menu.
2. Go to  **Advanced Settings**, and select .
3. Press  to enable or disable the **Burn Prevention** function.
4. Hold  to save settings and exit.

5.5 Hot Tracking

The device can detect the highest temperature spot in the scene and mark it on display.

Steps

1. Hold  to show the menu.
2. Go to  **Advanced Settings**, and select .
3. Press  to enable the function and mark the spot of highest temperature.
4. Hold  to save settings and exit.

Result





When the function is enabled,  displays in the spot of highest temperature. When the scene changes, the  moves.



Figure 5-1 Hot Tracking

5.6 Capture and Video

5.6.1 Capture Picture

In the live view interface, press  and  at the same time to capture pictures.







Note

- When capturing succeeds, the image freezes for 1 second and a prompt shows on the display.
 - For exporting captured pictures, refer to **Export Files**.
-

5.6.2 Set Audio

If you enable the audio function, the sound will be recorded with the video. When there is too loud noise in the video, you can turn off this function.

Steps

1. Hold  to show the menu.
2. Go to  **Advanced Settings**, and select .
3. Press  to enable or disable this function.
4. Hold  to save and exit.

5.6.3 Record Video

Steps

1. In the live view mode, hold  and start recording.



Figure 5-2 Record Video

2. Hold again to stop recording.

5.6.4

View Local Album

Captured images and recorded videos are automatically stored in the device, and you can view the files in local albums.

Steps

1. Hold to show the menu.
2. Go to **Advanced Settings**, and select .



Note



The albums are automatically created and named by year + month. The local pictures and videos of a certain month are stored in the corresponding album. For example, the pictures and videos of October in 2024 are saved in the album named 202410.

3. Press and to select an album and press to enter it.
4. Press and to select a file to view.
5. Press to view the selected file and relevant information.



Note

- Files are arranged in chronological order, with the most recent at the top. If you fails to find the most recently taken snapshots or videos, please check the time and date settings of your device. When you are viewing files, you can switch to other files by pressing and .
 - When you are viewing files, you can press to turn to next page, and press to go back to previous page.
-

- When you are viewing videos, you can press  to play or stop the video.
 - For deleting an album or a file, you can press  +  to call the dialogue box, and delete the album or file according to the prompt.
-

5.7 Export Files

5.7.1 Export Files via HIKMICRO Sight

You can access device albums and export files to your phone via HIKMICRO Sight.

Before You Start

Install HIKMICRO Sight on your mobile phone.

Steps

1. Open HIKMICRO Sight and connect your device to the app. See **App Connection**.
2. Tap Media to access device albums.

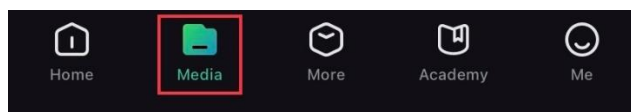

Figure 5-3 Access Device Albums

3. Tap **Local** or **Device** to view the photos and videos.
 - **Local**: You can view the previous files on the app.
 - **Device**: You can view the files of the current device.



Note

The photos or videos may not show in Device. Please pull down to refresh the page.

4. Tap to select a file, and tap Download to export the file to your local phone albums.



Figure 5-4 Export Files



Note

- Go to **Me > About > User Manual** on the app to see more detailed operations.
- You can also access device albums by tapping bottom left icon in the

live view interface.

- The exporting operation may vary due to app updates. Please take the actual app version for reference.
-









5.7.2 Export Files via PC

This function is used to export recorded videos and captured pictures.

Before You Start

Make sure the device is turned on when connecting the cable.

Steps

1. Hold  to show the menu.
 2. Go to  **Advanced Settings**, and press  or  to select .
 3. Press  to enter the configuration interface.
 4. Press  or  to select **USB Flash Drive**.
 5. Connect the device and PC with the Type-C cable.
-



Note

- Make sure the device is turned on when connecting the cable.
 - Open computer disk and select the disk of device. Go to the DCIM folder and find the folder named after the capture year and month. For example, if you capture a picture or record a video on October 2024, go to DCIM -> 202410 to find the picture or video.
-

6. Select and copy the files to PC.
 7. Disconnect the device from your PC.
-











Note

- The device displays images when you connect it to PC. But functions such as recording, capturing and hotspot are disabled.
 - When you connect the device to PC for the first time, it installs the drive program automatically.
-

6 System Settings













6.1 Adjust Date

Steps

1. Hold  to show the menu.
2. Go to  **Advanced Settings**, and select .
3. Press  to enter the configuration interface.
4. Press  to select the day, month, or year to be synchronized, and press  and  to change the number, then press  again to finish the setting.
5. Hold  to save settings and exit.

6.2 Adjust Time







Steps

1. Hold  to show the menu.
2. Go to  **Advanced Settings**, and select .
3. Press  to enter the configuration interface.
4. Press  and  to switch the clock system. 24-hour and 12-hour clock are selectable. If you select 12-hour clock, press  and then press  and  to select **AM** or **PM**.
5. Press  to select the hour or minute, and press  and  to change the number.
6. Hold  to save settings and exit.

6.3 Set Language

You can select the device language in this function.

Steps







1. Hold  to show the menu.
2. Go to  **Advanced Settings**, and select .
3. Press  to enter the language configuration interface.
4. Press  and  to select the language as required, and press  to confirm.

5. Hold  to save settings and exit.

6.4 Cast Device Screen to PC

The device supports casting screen to PC via a UVC protocol-based streaming media player. You can view the device image on the PC display for details.







Steps

1. Hold  to show the menu.
2. Go to  **Advanced Settings**, and select .
3. Press  to enter the configuration interface.
4. Press  and  to select **Digital**.
5. Hold  to save the settings and exit.
6. Open the UVC protocol-based player, and connect your device to the PC via the type-C cable.

6.5 Set Unit

You can switch the unit for distance display.





Steps

1. Hold  to show the menu.
2. Go to  **Advanced Settings**, and select .
3. Press  to enter the configuration interface.
4. Press  and  to select the unit as needed.
5. Hold  to save settings and exit.

6.6 Save Diagnostic Log

This functions helps to collect and save device operation logs for troubleshooting.

Steps

1. Hold  to show the menu.
2. Go to  **Advanced Settings**, and select .
3. Press  to enable the function. The device will start to collect and record the device log.

4. Press  to disable the function when the collection is finished.







Note

- When disabling the diagnostic log, a prompt will appear on the interface indicating the progress of diagnostic log collection. This operation cannot be interrupted. Once the log collection is finished, the prompt will disappear.
 - If you need to export the logs to the professionals, open computer disk to copy and paste the log package files (*.tar.gz) stored in the log folder in the root directory of the device. See **Export Files via PC**.
-

6.7 View Device Information





Steps

1. Hold  to show the menu.
2. Go to  **Advanced Settings**, and select .
3. Press  to view the device information such as available storage space, version, and serial No.
4. Hold  to exit.

6.8 Restore Device

This function only restores the device basic settings, such as brightness, contrast, and PIP to their defaults.





Steps

1. Hold  to show the menu.
2. Go to  **Advanced Settings**, and select .
3. Press  to restore the device to defaults according to the prompt.

6.9 Reset Device

This function erases all content and settings, including basic settings, storage, and hotspot password.

Steps

1. Hold  to show the menu.
2. Go to  **Advanced Settings**, and select .
3. Press  to restore the device to defaults according to the prompt.

7 Frequently Asked Questions

7.1 Why does the charge indicator flash improperly?

Check the following items.

- Check whether the device is charged with standard power adapter and the charging temperature is above 0 °C (32 °F).
- Charge the device in power off status.

7.2 Why is the power indicator off?

Check whether the device is off-battery. Check the indicator after charging the device for 5 minutes.

7.3 The image is not clear, how to adjust it?

Adjust the diopter adjustment ring or focus ring until the image is clear. Refer to *Adjust Diopter* or *Adjust Focus*.

7.4 Capturing or recording fails. What's the problem?

Check the following items.

- Whether the device is connected to your PC. Capturing or recording is turned off in this status.
- Whether the storage space is full.
- Whether the device is low-battery.

7.5 Why the PC cannot identify the device?

Check the following items.

- Whether the USB connection mode is **USB Flash Drive**.
- Whether the device is connected to your PC with supplied USB cable.
- If you use other USB cables, make sure the cable length is no longer than 1 m.

Legal Information

©Hangzhou Microimage Software Co., Ltd. All rights reserved.

About this Manual

The Manual includes instructions for using and managing the Product. Pictures, charts, images and all other information hereinafter are for description and explanation only. The information contained in the Manual is subject to change, without notice, due to firmware updates or other reasons. Please find the latest version of this Manual at the HIKMICRO website (www.hikmicrotech.com).

Please use this Manual with the guidance and assistance of professionals trained in supporting the Product.

Trademarks Acknowledgement

 **HIKMICRO** and other HIKMICRO's trademarks and logos are the properties of HIKMICRO in various jurisdictions.

Other trademarks and logos mentioned are the properties of their respective owners.

LEGAL DISCLAIMER

TO THE MAXIMUM EXTENT PERMITTED BY APPLICABLE LAW, THIS MANUAL AND THE PRODUCT DESCRIBED, WITH ITS HARDWARE, SOFTWARE AND FIRMWARE, ARE PROVIDED "AS IS" AND "WITH ALL FAULTS AND ERRORS". HIKMICRO MAKES NO WARRANTIES, EXPRESS OR IMPLIED, INCLUDING WITHOUT LIMITATION, MERCHANTABILITY, SATISFACTORY QUALITY, OR FITNESS FOR A PARTICULAR PURPOSE. THE USE OF THE PRODUCT BY YOU IS AT YOUR OWN RISK. IN NO EVENT WILL HIKMICRO BE LIABLE TO YOU FOR ANY SPECIAL, CONSEQUENTIAL, INCIDENTAL, OR INDIRECT DAMAGES, INCLUDING, AMONG OTHERS, DAMAGES FOR LOSS OF BUSINESS PROFITS, BUSINESS INTERRUPTION, OR LOSS OF DATA, CORRUPTION OF SYSTEMS, OR LOSS OF DOCUMENTATION, WHETHER BASED ON BREACH OF CONTRACT, TORT (INCLUDING NEGLIGENCE), PRODUCT LIABILITY, OR OTHERWISE, IN CONNECTION WITH THE USE OF THE PRODUCT, EVEN IF HIKMICRO HAS BEEN ADVISED OF THE POSSIBILITY OF SUCH DAMAGES OR LOSS.

YOU ACKNOWLEDGE THAT THE NATURE OF THE INTERNET PROVIDES FOR INHERENT SECURITY RISKS, AND HIKMICRO SHALL NOT TAKE ANY RESPONSIBILITIES FOR ABNORMAL OPERATION, PRIVACY LEAKAGE OR OTHER DAMAGES RESULTING FROM CYBER-ATTACK, HACKER ATTACK, VIRUS INFECTION, OR OTHER INTERNET SECURITY RISKS; HOWEVER, HIKMICRO WILL PROVIDE TIMELY TECHNICAL SUPPORT IF REQUIRED.

Thermal Monocular User Manual

YOU AGREE TO USE THIS PRODUCT IN COMPLIANCE WITH ALL APPLICABLE LAWS, AND YOU ARE SOLELY RESPONSIBLE FOR ENSURING THAT YOUR USE CONFORMS TO THE APPLICABLE LAW. ESPECIALLY, YOU ARE RESPONSIBLE, FOR USING THIS PRODUCT IN A MANNER THAT DOES NOT INFRINGE ON THE RIGHTS OF THIRD PARTIES, INCLUDING WITHOUT LIMITATION, RIGHTS OF PUBLICITY, INTELLECTUAL PROPERTY RIGHTS, OR DATA PROTECTION AND OTHER PRIVACY RIGHTS. YOU SHALL NOT USE THIS PRODUCT FOR ILLEGAL HUNTING ANIMALS, INVASION OF PRIVACY OR ANY OTHER PURPOSE WHICH IS ILLEGAL OR DETRIMENTAL TO THE PUBLIC INTEREST. YOU SHALL NOT USE THIS PRODUCT FOR ANY PROHIBITED END-USES, INCLUDING THE DEVELOPMENT OR PRODUCTION OF WEAPONS OF MASS DESTRUCTION, THE DEVELOPMENT OR PRODUCTION OF CHEMICAL OR BIOLOGICAL WEAPONS, ANY ACTIVITIES IN THE CONTEXT RELATED TO ANY NUCLEAR EXPLOSIVE OR UNSAFE NUCLEAR FUEL-CYCLE, OR IN SUPPORT OF HUMAN RIGHTS ABUSES.

IN THE EVENT OF ANY CONFLICTS BETWEEN THIS MANUAL AND THE APPLICABLE LAW, THE LATTER PREVAILS.

Regulatory Information

These clauses apply only to the products bearing the corresponding mark or information.

EU Conformity Statement



This product and - if applicable - the supplied accessories too are marked with "CE" and comply therefore with the applicable harmonized European standards listed under the Directive 2014/30/EU (EMCD), Directive 2014/35/EU (LVD), Directive 2011/65/EU (RoHS), Directive 2014/53/EU. Hereby, Hangzhou Microimage Software Co., Ltd. declares that this device (refer to the label) is in compliance with Directive 2014/53/EU.

The full text of the EU declaration of conformity is available at the following internet address:

<https://www.hikmicrotech.com/en/support/download-center/declaration-of-conformity/>

Frequency Bands and Power (for CE)

The frequency bands and transmitting power (radiated and/or conducted) nominal limits applicable to the following radio equipment are as follows:

Wi-Fi 2.4 GHz (2.4 GHz to 2.4835 GHz): 20 dBm

Wi-Fi 5 GHz (5.15 GHz to 5.25 GHz): 23 dBm

5.15 ~ 5.25 GHz 屋内使用のみ。

For the device without a supplied power adapter, use the power adapter provided by a qualified manufacturer. Refer to the product specification for detailed power requirements.

For the device without a supplied battery, use the battery provided by a qualified manufacturer. Refer to the product specification for detailed battery requirements.



Directive 2012/19/EU (WEEE Directive): Products marked with this symbol cannot be disposed of as unsorted municipal waste in the European Union. For proper recycling, return this product to your local supplier upon the purchase of equivalent new equipment, or dispose of it at designated collection points. For more information see: www.recyclethis.info

Regulation (EU) 2023/1542 (Battery Regulation): This product contains a battery and it is in conformity with the Regulation (EU) 2023/1542. The battery cannot be disposed of as unsorted municipal waste in the European Union. See the product documentation for specific battery information. The battery is marked with this symbol, which



may include lettering to indicate cadmium (Cd), or lead (Pb). For proper recycling, return the battery to your supplier or to a designated collection point. For more information see: www.recyclethis.info.

KC

B 급 기기: 이 기기는 가정용(B 급) 전자파적합기기로서 주로 가정에서 사용하는 것을 목적으로 하며, 모든 지역에서 사용할 수 있습니다.

INFORMATIONEN FÜR PRIVATE HAUSHALTE

1. Getrennte Erfassung von Altgeräten:

Elektro- und Elektronikgeräte, die zu Abfall geworden sind, werden als Altgeräte bezeichnet. Besitzer von Altgeräten haben diese einer vom unsortierten Siedlungsabfall getrennten Erfassung zuzuführen. Altgeräte gehören insbesondere nicht in den Hausmüll, sondern in spezielle Sammel- und Rückgabesysteme.

2. Batterien und Akkus sowie Lampen:

Besitzer von Altgeräten haben Altbatterien und Altakkumulatoren, die nicht vom Altgerät umschlossen sind, die zerstörungsfrei aus dem Altgerät entnommen werden können, im Regelfall vor der Abgabe an einer Erfassungsstelle vom Altgerät zu trennen. Dies gilt nicht, soweit Altgeräte einer Vorbereitung zur Wiederverwendung unter Beteiligung eines öffentlich-rechtlichen Entsorgungsträgers zugeführt werden.

3. Möglichkeiten der Rückgabe von Altgeräten:

Besitzer von Altgeräten aus privaten Haushalten können diese bei den Sammelstellen der öffentlich-rechtlichen Entsorgungsträger oder bei den von Herstellern oder Vertriebern im Sinne des ElektroG eingerichteten Rücknahmestellen unentgeltlich abgeben. Rücknahmepflichtig sind Geschäfte mit einer Verkaufsfläche von mindestens 400 m² für Elektro- und Elektronikgeräte sowie diejenigen Lebensmittelgeschäfte mit einer Gesamtverkaufsfläche von mindestens 800 m², die mehrmals pro Jahr oder dauerhaft Elektro- und Elektronikgeräte anbieten und auf dem Markt bereitstellen. Dies gilt auch bei Vertrieb unter Verwendung von Fernkommunikationsmitteln, wenn die Lager- und Versandflächen für Elektro- und Elektronikgeräte mindestens 400 m² betragen oder die gesamten Lager- und Versandflächen mindestens 800 m² betragen. Vertrieber haben die Rücknahme grundsätzlich durch geeignete Rückgabemöglichkeiten in zumutbarer Entfernung zum jeweiligen Endnutzer zu gewährleisten. Die Möglichkeit der unentgeltlichen Rückgabe eines Altgerätes besteht bei rücknahmepflichtigen Vertriebern unter anderem dann, wenn ein neues gleichartiges Gerät, das im

Wesentlichen die gleichen Funktionen erfüllt, an einen Endnutzer abgegeben wird.

4. Datenschutz-Hinweis:

Altgeräte enthalten häufig sensible personenbezogene Daten. Dies gilt insbesondere für Geräte der Informations- und Telekommunikationstechnik wie Computer und Smartphones. Bitte beachten Sie in Ihrem eigenen Interesse, dass für die Löschung der Daten auf den zu entsorgenden Altgeräten jeder Endnutzer selbst verantwortlich ist.



5. Bedeutung des Symbols „durchgestrichene Mülltonne“:



Das auf Elektro- und Elektronikgeräten regelmäßig abgebildete Symbol einer durchgestrichenen Mülltonne weist darauf hin, dass das jeweilige Gerät am Ende seiner Lebensdauer getrennt vom unsortierten Siedlungsabfall zu erfassen ist.

Symbol Conventions

The symbols that may be found in this document are defined as follows.

Symbol	Description
 Note	Provides additional information to emphasize or supplement important points of the main text.
 Caution	Indicates a potentially hazardous situation, which if not avoided, could result in equipment damage, data loss, performance degradation, or unexpected results.
 Danger	Indicates a hazard with a high level of risk, which if not avoided, will result in death or serious injury.

Safety Instruction

These instructions are intended to ensure that user can use the product correctly to avoid danger or property loss. Please read all the safety information carefully before using.

Transportation

- Keep the device in original or similar packaging while transporting it.
- Keep all wrappers after unpacking them for future use. In case of any failure occurred, you need to return the device to the factory with the original wrapper.
- Transportation without the original wrapper may result in damage on the device and the company shall not take any responsibilities.
- Do not drop the product or subject it to physical shock. Keep the device away from magnetic interference.

Power Supply

- If a power adapter is provided in the device package, use the provided adapter only. If no power adapter is provided, ensure the power adapter or other power supply complies with Limited Power Source. Refer to the product label for the power supply output parameters.
- The power delivered by the charger must be between min 8.4 Watts required by the radio equipment, and max 12 Watts in order to achieve the maximum charging speed.
- Make sure the plug is properly connected to the power socket.
- DO NOT connect multiple devices to one power adapter, to avoid overheating or fire hazards caused by overload.

Battery

- The device supports removable Li-ion battery. The battery rated voltage and capacity is 3.59 V/5500 mAh.
- CAUTION: Risk of explosion if the battery is replaced by an incorrect type. Replace with the same or equivalent type only.
- Batteries of improper size cannot be installed, and may cause abnormal shutdown.
- Improper replacement of the battery with an incorrect type may defeat a safeguard (for example, in the case of some lithium battery types).
- Please purchase the batteries recommended by the manufacturer if necessary.
- The purchased batteries by users need to comply with the relevant international standards about battery safety (e.g. EN/IEC standards).
- Use the battery provided by qualified manufacturer. Refer to the product specification for detailed battery requirements.
- Dispose of used batteries according to the instructions.
- Remove the battery if you do not use the device for a long time.

- For long-term storage of the battery, make sure it is fully charged every half year to ensure the battery quality. Otherwise, damage may occur.
- The built-in battery cannot be dismantled. Please contact the manufacture for repair if necessary.
- Install the external battery before the built-in battery runs out, or the device cannot be turned on.
- Make sure the battery temperature is between 0°C to 50°C (32°F to 122°F) when charging.
- Do not dispose of the battery into fire or a hot oven, or mechanically crush or cut the battery, which may result in an explosion.
- Do not leave the battery in an extremely high temperature or low air pressure environment, which may result in an explosion or the leakage of flammable liquid or gas.
- Confirm there is no flammable material within 2 m of the charger during charging.
- DO NOT place the device with battery or the battery alone near heating or fire source. Avoid direct sunlight.
- DO NOT place the battery in the reach of children.
- DO NOT swallow the battery to avoid chemical burns.
- This product contains a coin/button cell battery. If the coin/button cell battery is swallowed, it can cause severe internal burns in just 2 hours and can lead to death.
- If the battery compartment does not close securely, stop using the product and keep it away from children.
- If you think batteries might have been swallowed or placed inside any part of the body, seek immediate medical attention.

Maintenance

- If the product does not work properly, please contact your dealer or the nearest service center. We shall not assume any responsibility for problems caused by unauthorized repair or maintenance.
- Make sure that the power has been disconnected before device teardown and repair by professionals.
- Check the optical surfaces of objective lens, eyepiece, rangefinder, etc. If necessary, remove dust and sand from the optics using tools and solvent designed especially for this purpose (it is preferable to use a non-contact method).
- Wipe the exterior surfaces of metal, plastic and silicone parts with a clean and soft cloth. Do not use chemically active substances, solvents, etc. as these may damage the paint.
- Clean the electrical contacts of the battery on the device using a non-greasy organic solvent.
- If the equipment is used in a manner not specified by the manufacturer, the protection provided by the device may be impaired.

Using Environment

- Make sure the running environment meets the requirement of the device. The operating temperature shall be -30 °C to 55 °C (-22 °F to 131 °F), and the operating humidity shall be from 5% to 95%.
- DO NOT expose the device to high electromagnetic radiation or dusty environments.
- DO NOT aim the lens at the sun or any other bright light.
- Place the device in a dry and well-ventilated environment.
- When any laser equipment is in use, make sure that the device lens is not exposed to the laser beam, or it may burn out.
- Avoid equipment installation on vibratory surface or places subject to shock (neglect may cause equipment damage).
- This equipment is not suitable for use in locations where children are likely to be present.

Emergency

If smoke, odor, or noise arises from the device, immediately turn off the power, unplug the power cable, and contact the service center.

Laser



When any laser equipment is in use, make sure that the device lens is not exposed to the laser beam, or it may burn out. The laser radiation emitted from the device can cause eye injuries, burning of skin or inflammable

substances. Before enabling the laser ranging function, make sure no human or inflammable substances are in front of the laser lens. Do not place the device where minors can fetch it. According to IEC 60825-1:2014, EN 60825-1:2014+A11:2021, and EN 50689:2021, this laser product is classified as Class 1 laser product and consumer laser product.

Limited Warranty

Scan the QR code for the product warranty policy.



Manufacture Address

Room 313, Unit B, Building 2, 399 Danfeng Road, Xixing Subdistrict,
Binjiang District, Hangzhou, Zhejiang 310052, China

Hangzhou Microimage Software Co., Ltd.

COMPLIANCE NOTICE: The thermal series products might be subject to export controls in various countries or regions, including without limitation, the United States, European Union, United Kingdom and/or other member countries of the Wassenaar Arrangement. Please consult your professional legal or compliance expert or local government authorities for any necessary export license requirements if you intend to transfer, export, re-export the thermal series products between different countries.



 Hikmicro Hunting.Global

 Hikmicro Hunting.Global

 HIKMICRO Outdoor

 HIKMICRO

 www.hikmicrotech.com

 support@hikmicrotech.com

UD40929B