



ATHLON
OPTICS

CRONUS 10x50 BINOCULARS

- LASER RANGEFINDER -

USER MANUAL
AND CARE INSTRUCTIONS



Cronus Laser Binocular Elements

- | | |
|----------------------------|----------------------|
| ① "Mode" Button | ⑤ Display Focus |
| ② "Ranging"/"Power" Button | ⑥ Diopter Adjustment |
| ③ Focusing Wheel | ⑦ Battery Chamber |
| ④ Eyecup | |

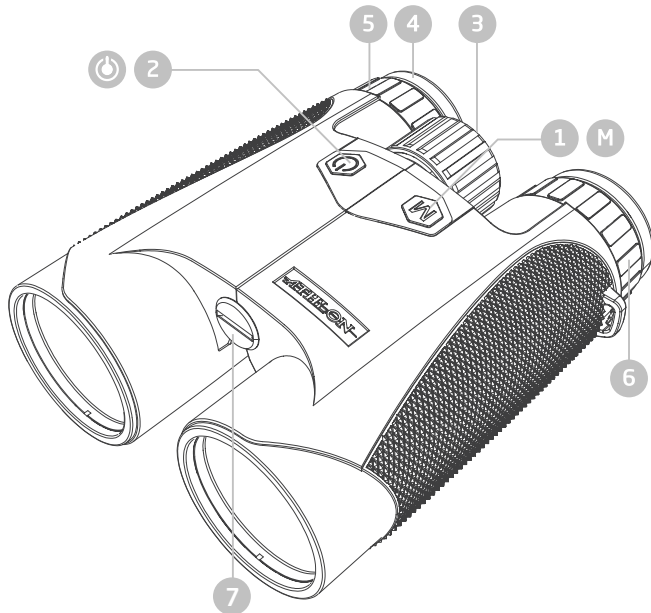

Installing the Battery

- i. Using a coin, remove the battery cap from the front hinge of the binoculars by turning counter clock-wise.
- ii. Insert the battery (CR2) with the positive side facing up (Fig.1). Put the battery cap on.

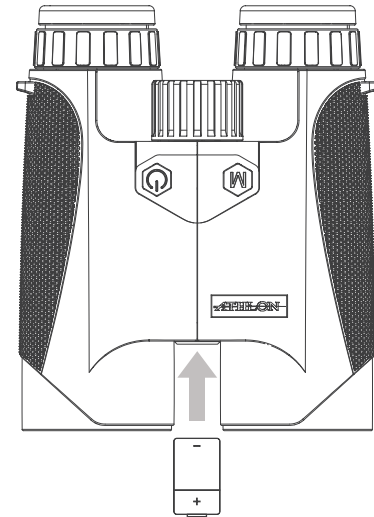



Fig.1

Startup and Shutdown

- iii. Press  button to power on the device. You should see the startup display (Fig.2) by looking through the eyepiece;

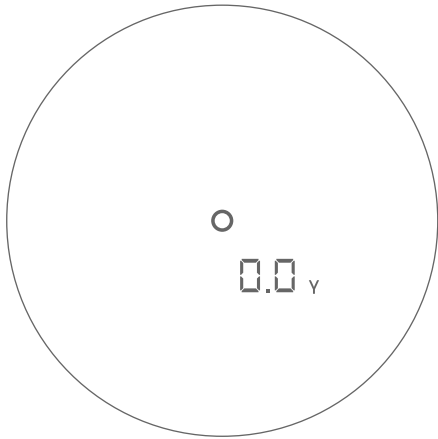



Fig.2

- iv. While the display is active, hold the circle reticle on your target, press the  button to range the target.
- v. The binoculars will power-off after remaining idle for 25 seconds.

Setting the Display Focus and Diopter

These binoculars have a diopter (1), display focus (2), and a focusing wheel (3)(Fig.3). The diopter and display focus will need to be adjusted only once, before your first use, to ensure a clear display and image simultaneously.

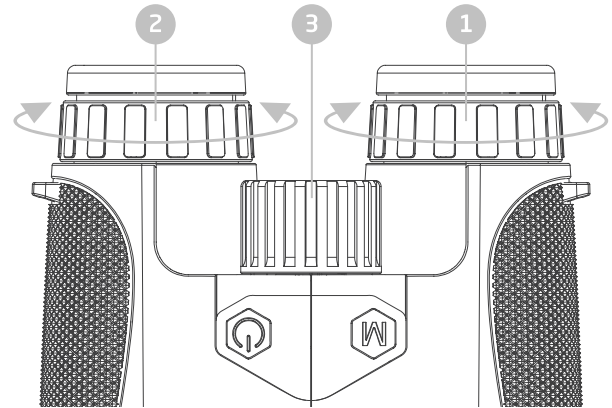







Fig.3

- i. Press the  button to see the display. Use the display focus to adjust until the display is clear.

- ii. Keep both eyes open during this set-up. Begin by covering the left objective with your hand. Using the focusing wheel, adjust until you have a clear image. Once achieved, do not move the focus wheel.
- iii. Switch hands and cover the right objective this time. Adjust the left diopter until you can see clearly.
- iv. With both objectives uncovered you should have a clear image. You can now use the focusing wheel freely.

Changing settings and navigating the Menu

- i. Press the  button to power on the device.
- ii. To enter the menu screens, hold the  button for approximately 3 seconds.
- iii. Using the  button, you can scroll through the icons. A flashing icon indicates it is selected.
- iv. To advance to the next screen, press the  button.

Menu Screens

- i. Select Measuring units (Fig.4):
 - Yards vs Meters

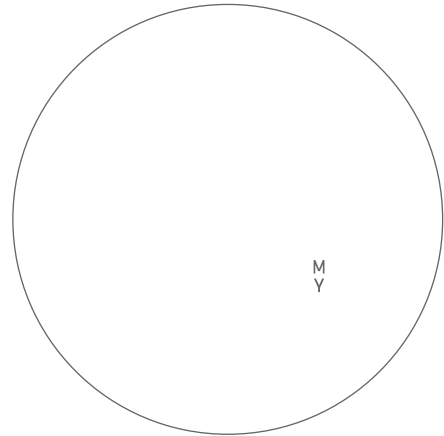

Fig.4

ii. Ranging modes (Fig.5):

- **Incline Angle (T)** mode displays the incline angle of your position to the target.
- **Vertical Distance (V)** mode displays the vertical distance of your position to the target.
- **Horizontal Distance (H)** mode displays the angle compensated distance to the target. This is the primary mode used by most hunters (Both bow and rifle).
- **OFF** will only provide line-of-sight distances.

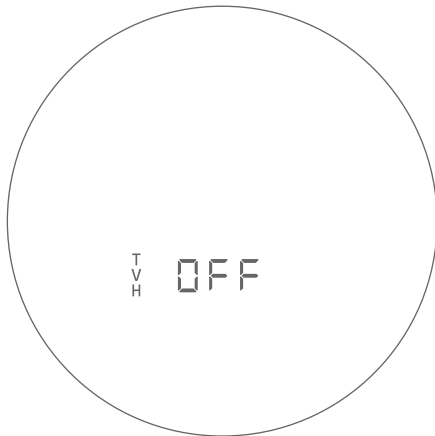

Fig.5

iii. Measuring Method (Fig.6):

- **Auto** will automatically decide which setting to use: hunt vs golf
- **Golf mode** is used to measure smaller objects. The Binoculars will display the closest distance when the device detects several objects or background.
- **Hunt mode** will give the furthest distance when the device detects several objects or background.

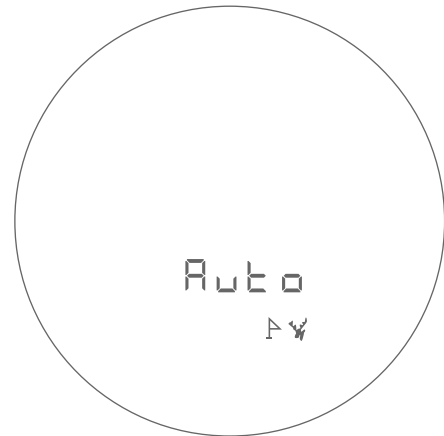



Fig.6

iv. Display Brightness (Fig.7):

- Adjust the brightness of the display, cycle through the brightness levels by pressing the  button.

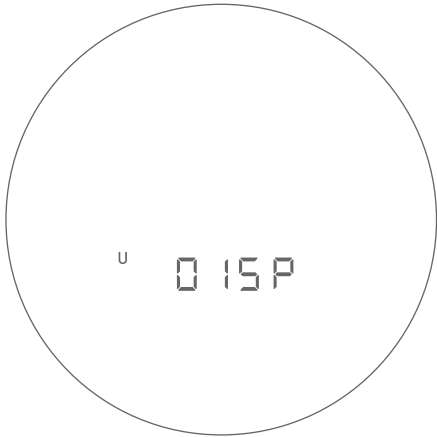

Fig.7



THE ATHLON GOLD MEDAL LIFETIME WARRANTY*

Your Athlon product is not only warranted to be free of defects in materials and workmanship for the lifetime of the product. Athlon will also repair or replace, at no charge to you, your product if you should damage it through normal use. No receipt is needed, no registration is required. This is a commitment that Athlon Optics will be the best product you can buy for your money.

**This warranty does not cover damages caused by deliberate damage, misuse, theft or maintenance provided by someone other than the Athlon Authorized Service Department.*



TOLL FREE: 1-855-913-5678



CONTACT@ATHLONOPTICS.COM



801 N MEADOWBROOK DR, OLATHE, KS 66062